

Controls – 3RF Solid-State Switching Devices

4



4/2	Introduction
4/3	Solid-State Switching Devices General data
4/6 4/7 4/10	Solid-State Relays General data 3RF21 solid-state relays, 22.5 mm 3RF20 solid-state relays, 45 mm
4/11 4/12	Solid-State Contactors General data 3RF23 solid-state contactors
4/17 4/22 4/23 4/24	3RF29 Function Modules General data Converters Load and heating current monitoring Power controllers

Controls – Solid-State Switching Devices

Introduction

Overview

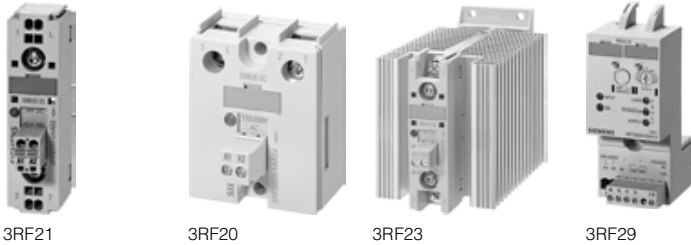

3RF21

3RF20

3RF23

3RF29

	Order No.	Page
SIRIUS SC solid-state switching devices		
Solid-state relays		
22.5 mm solid-state relays, 45 mm solid-state relays	3RF21, 3RF20	4/7 4/10
Solid-state contactors	3RF23	4/11
Function modules	For extending the functionality of the 3RF21 solid-state relays and the 3RF23 solid-state contactors for many different applications:	
Converters	3RF29 00-0EA18	4/22
Load monitoring	3RF29 20-0FA08, 3RF29 .0-0GA..	4/23
Heating current monitoring	3RF29 ...0JA..	4/23
Power controllers	3RF29 .0-0HA..	4/24

Overview

SIRIUS SC solid-state switching devices

- Solid-state relays
- Solid-state contactors
- Function modules

SIRIUS SC – for almost unending activity

Conventional electromechanical switching devices are often overtaxed by the rise in the number of switching operations. A high switching frequency results in frequent failure and short replacement cycles. However, this does not have to be the case, because with the latest generation of our SIRIUS SC solid-state switching devices we provide you with solid-state relays and contactors with a particularly long service life – for almost unending activity even under the toughest conditions and under high mechanical load, but also in noise-sensitive areas.

Proved time and again in service

SIRIUS SC solid-state switching devices have become firmly established in industrial use. They are used above all in applications where loads are switched frequently – mainly with resistive load controllers, with the control of electrical heat or the control of valves and motors in conveyor systems. In addition to its use in areas with high switching frequencies, thanks to its

silent switching SIRIUS SC is also ideally suited to noise-sensitive areas such as offices or hospitals.

The most reliable solution for any application

Compared with mechanical switching devices, our SIRIUS SC solid-state switching devices stand out because of their considerably longer service life. Thanks to the high product quality, their switching is extremely precise, reliable and above all insensitive to faults. With its variable connection methods and a wide spread of control voltages, the SIRIUS SC family is universally applicable. Depending on the individual requirements of the application, our modular switching devices can also be quite easily expanded by the addition of standardized function modules.

Always on the sunny side with SIRIUS SC

Because SIRIUS SC offers even more:

- The space-saving and compact side-by-side mounting ensures reliable operation up to an ambient temperature of +60 °C.
- Thanks to fast configuration and the ease of installation and start-up, you save not only time but also expenses.

Type	Solid-state relay		Solid-state contactor	Function module				
	22.5 mm	45 mm		Converter	Load monitoring Basic	Extended	Heating current monitoring	Power controllers
Usage								
Simple use of existing solid-state relays	<input type="checkbox"/>	✓	<input type="checkbox"/>	--	--	--	--	--
Complete "Ready to use"	<input type="checkbox"/>	<input type="checkbox"/>	✓	--	--	--	--	--
Space-saving	✓	--	✓	✓	✓	--	--	--
Can be extended with modular function modules	✓	--	✓	--	--	--	--	--
Frequent switching and monitoring of loads and solid-state relays/solid-state contactors	--	--	--	--	✓	✓	✓	✓
Monitoring of up to 6 partial loads	--	--	--	--	--	--	✓	--
Monitoring of more than 6 partial loads	--	--	--	--	--	✓	--	--
Control of the heating power through an analog input	--	--	--	✓	--	--	--	✓
Power control	--	--	--	--	--	--	--	✓
Start-up								
Easy setting of setpoints with "Teach" button	--	--	--	--	✓	✓	--	✓
"Remote Teach" input for setting setpoints	--	--	--	--	--	--	✓	--
Mounting								
Mounting onto mounting rails or mounting plates	--	--	✓	--	--	--	--	--
Can be snapped directly onto a solid-state relay or contactor	--	--	--	✓	✓	✓	✓	✓
For use with "Coolplate" heat sink	✓	✓	--	--	--	--	--	--
Cable routing								
Connection of load circuit as for controlgear	✓	--	✓	--	✓	✓	✓	✓
Connection of load circuit from above	--	✓	--	--	--	--	--	--

- ✓ function is available
- function is possible

Solid-State Switching Devices

General data

Benefits

- Considerable space savings thanks to a width of only 22.5 mm
- Variety of connection techniques: Screw connection, spring-type connection or ring terminal end, there is no problem – they are all finger-safe
- Flexible for all applications with function modules for retrofitting
- Possibility of fuseless short-circuit resistant design

Advantages:

- Saves time and costs with fast installation and commissioning, short setting-up times and easy wiring
- Extremely long life, low maintenance, rugged and reliable
- Space-saving and safe thanks to side-by-side mounting up to an ambient temperature of +60 °C
- Modular design: Standardized function modules and heat sinks can be used in conjunction with solid-state relays to satisfy individual requirements
- Safety due to lifelong, vibration-resistant and shock-resistant spring-loaded terminal connection system even under tough conditions

Application

Uses

Example plastic machine industry:

Thanks to their high switching endurance, SIRIUS SC solid-state switching devices are ideally suited for use in the control of electrical heat. This is because the more precise the temperature regulation process has to be, the higher the switching frequency. The accurate regulation of electrical heat is used for example in many processes in the plastic machine industry:

- Band heaters heat the extrudate to the correct temperature in plastic extruders
- Heat emitters heat plastic blanks to the correct temperature
- Heat drums dry plastic granules
- Heating channels keep molds at the correct temperature in order to manufacture different plastic parts without defects

The powerful SIRIUS SC solid-state relays and contactors can be used to control several heating loads at the same time. By using a load monitoring module the individual partial loads can easily be monitored, and in the event of a failure a signal is generated to be sent to the controller.

Protecting the solid-state relays and solid-state contactors with miniature circuit-breakers (MCB with type B tripping characteristic)

Short-circuit protection and line protection with miniature circuit-breakers is easy to achieve with SIRIUS SC solid-state relays and solid-state contactors in comparison with designing load feeders with fuses. A special version of the solid-state contactors can be protected against damage in the case of a short-circuit with a miniature circuit-breaker with type B tripping characteristic. This allows the low-cost and simple design of fuseless load feeders with full protection of the switching device.

Selection and ordering data

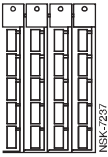
Designation	Labeling area (W x H) mm x mm	Color	DT	Order No.	Price per PU	PU (UNIT, SET, M)	PS*	PG	Weight per PU approx. kg	
Blank labeling plates										
 Unit labeling plates (1 frame = 20 units)	Unit labeling plates for "SIRIUS"¹⁾	10 x 7	pastel turquoise	D	3RT19 00-1SB10		100	816 units	101	0.240
		20 x 7	pastel turquoise	C	3RT19 00-1SB20		100	340 units	101	0.220
	Labels for sticking for "SIRIUS"	19 x 6	pastel turquoise	D	3RT19 00-1SB60		100	3060 units	101	0.155
		19 x 6	zinc yellow	C	3RT19 00-1SD60		100	3060 units	101	0.120

1) Computer labeling system for individual labeling of unit labeling plates available from: murrplastik Systemtechnik GmbH (<http://www.murrplastik.com>).

More information

Notes on integration in the load feeders

The SIRIUS SC solid-state switching devices are very easy to integrate into the load feeders thanks to their industrial connection technology and design.

Particular attention must however be paid to the circumstances of the installation and ambient conditions, as the performance of the solid-state switching devices is largely dependent on these. Depending on the version, certain restrictions must be observed. Detailed information, for example in relation to solid-state contactors about the minimum spacing and to solid-state relays about the choice of heat sink, is given in the product data sheets and the technical specifications in the A&D Mall.

Despite the rugged power semiconductors that are used, solid-state switching devices respond more sensitively to short-circuits in the load feeder. Consequently, special precautions have to be taken against destruction, depending on the type of design.

Siemens generally recommends using SITOR solid-state protection fuses. These fuses also provide protection against destruction in the event of a short-circuit even when the solid-state contactors and solid-state relays are fully utilized.

Alternatively, if there is lower loading, protection can also be provided by standard fuses or miniature circuit-breakers. This protection is achieved by overdimensioning the solid-state switching devices accordingly. The technical specifications in the A&D Mall and the product data sheets contain details both about the solid-state fuse protection itself and about use of the SIRIUS SC devices with conventional protection equipment.

The SIRIUS SC solid-state switching devices are suitable for interference-free operation in industrial power systems without further measures. If they are used in public power systems, it may be necessary for conducted interference to be reduced by means of filters. This does not include the special solid-state contactors of type 3RF23...CA.. "Low Noise". These comply with the class B limit values up to a rated current of 16 A. If other versions are used, and at currents of over 16 A, standard filters can be used in order to comply with the limit values. The decisive factors when it comes to selecting the filters are essentially the current loading and the other parameters (operational voltage, design type, etc.) in the load feeder.

Suitable filters can be ordered from EPCOS AG.

You can find more information on the Internet at:

<http://www.epcos.com>

* You can order this quantity or a multiple thereof.

Solid-State Relays

General data

Overview

Solid-state relays

SIRIUS SC solid-state relays are suitable for surface mounting on existing cooling surfaces. Installation is quick and easy, involving just two screws. The special technology of the power semiconductor ensures there is excellent thermal contact with the heat sink. Depending on the nature of the heat sink, the capacity reaches up to 88 A on resistive loads. The 3RF21 solid-state relays can be expanded with various function modules to adapt them to individual applications.

The solid-state relays are available in 2 different widths:

- 3RF21 solid-state relay with a width of 22.5 mm
- 3RF20 solid-state relay with a width of 45 mm

Version for resistive loads, "Zero-point switching"

This standard version is often used for switching space heaters on and off.

Version for inductive loads, "Instantaneous switching"

In this version the solid-state contactor is specifically matched to inductive loads. Whether it is a matter of frequent actuation of the valves in a filling plant or starting and stopping small drives in packet distribution systems, operation is carried out safely and noiselessly.

22.5 mm solid-state relay

With its compact design, which stays the same even at currents of up to 88 A, the 3RF21 steady-state relay is the ultimate in space-saving construction, at a width of 22.5 mm. The logical connection method, with the power infeed from above and connection of the load from below, ensures tidy installation in the control cabinet.

45 mm solid-state relay

The steady-state relays with a width of 45 mm provide for connection of the power supply lead and the load from above. This makes it easy to replace existing steady-state relays in existing arrangements. The connection of the control cable also saves space in much the same way as the 22.5 mm design, as it is simply plugged on.

More information

Selecting solid-state relays

When selecting solid-state relays, in addition to information about the power system, the load and the ambient conditions it is also necessary to know details of the planned design. The solid-state relays can only conform to their specific technical specifications if they are mounted with appropriate care on an adequately dimensioned heat sink. The following procedure is recommended:

- Determine the rated current of the load and the mains voltage
- Select the relay design and choose a solid-state relay with higher rated current than the load
- Determine the thermal resistance of the proposed heat sink
- Check the correct relay size with the aid of the diagrams

You can find more information on the Internet at:

<http://www.siemens.com/siriussc>

Solid-State Relays

3RF21 solid-state relays, 22.5 mm

Selection and ordering data

Type current ¹⁾	Maximum achievable power for type current and			DT	Screw connection ²⁾	PU (UNIT, SET, M)	PS*	PG	Weight per PU approx.	
	$U_e = 115\text{ V}$	$U_e = 230\text{ V}$	$U_e = 400\text{ V}$							
A	kW	kW	kW		Order No.	Price per PU			kg	
Zero-point switching, rated operating voltage U_e 24 V ... 230 V										
Rated control supply voltage 24 V DC according to EN 61131-2										
	20	2.3	4.6	--	A	3RF21 20-1AA02	1	1 unit	101	0.075
	30	3.5	6.9	--	A	3RF21 30-1AA02	1	1 unit	101	0.075
	50	5.8	11.5	--	A	3RF21 50-1AA02	1	1 unit	101	0.075
	70	8.1	16.1	--	B	3RF21 70-1AA02	1	1 unit	101	0.075
	90	10.4	20.7	--	B	3RF21 90-1AA02	1	1 unit	101	0.075
Rated control supply voltage 110 ... 230 V AC										
	20	2.3	4.6	--	B	3RF21 20-1AA22	1	1 unit	101	0.075
	30	3.5	6.9	--	B	3RF21 30-1AA22	1	1 unit	101	0.075
	50	5.8	11.5	--	A	3RF21 50-1AA22	1	1 unit	101	0.075
	70	8.1	16.1	--	B	3RF21 70-1AA22	1	1 unit	101	0.075
	90	10.4	20.7	--	B	3RF21 90-1AA22	1	1 unit	101	0.075
Rated control supply voltage 4 ... 30 V DC										
	20	2.3	4.6	--	B	3RF21 20-1AA42	1	1 unit	101	0.075
	30	3.5	6.9	--	B	3RF21 30-1AA42	1	1 unit	101	0.075
Zero-point switching, rated operating voltage U_e 230 V ... 460 V										
Rated control supply voltage 24 V DC according to EN 61131-2										
	20	--	4.6	8	A	3RF21 20-1AA04	1	1 unit	101	0.075
	30	--	6.9	12	A	3RF21 30-1AA04	1	1 unit	101	0.075
	50	--	11.5	20	A	3RF21 50-1AA04	1	1 unit	101	0.075
	70	--	16.1	28	A	3RF21 70-1AA04	1	1 unit	101	0.075
	90	--	20.7	36	A	3RF21 90-1AA04	1	1 unit	101	0.075
Rated control supply voltage 110 ... 230 V AC										
	20	--	4.6	8	B	3RF21 20-1AA24	1	1 unit	101	0.075
	30	--	6.9	12	B	3RF21 30-1AA24	1	1 unit	101	0.075
	50	--	11.5	20	B	3RF21 50-1AA24	1	1 unit	101	0.075
	70	--	16.1	28	B	3RF21 70-1AA24	1	1 unit	101	0.075
	90	--	20.7	36	B	3RF21 90-1AA24	1	1 unit	101	0.075
Zero-point switching, rated operating voltage U_e 48 V ... 600 V										
Rated control supply voltage 4 ... 30 V DC										
	70	8.1	16.1	28	B	3RF21 70-1AA45	1	1 unit	101	0.075
Zero-point switching, rated operating voltage U_e 400 V ... 600 V										
Rated control supply voltage 24 V DC according to EN 61131-2										
	30	--	--	12	B	3RF21 30-1AA06	1	1 unit	101	0.075
	50	--	--	20	B	3RF21 50-1AA06	1	1 unit	101	0.075
	70	--	--	28	B	3RF21 70-1AA06	1	1 unit	101	0.075
	90	--	--	36	B	3RF21 90-1AA06	1	1 unit	101	0.075
Rated control supply voltage 110 ... 230 V AC										
	30	--	--	12	B	3RF21 30-1AA26	1	1 unit	101	0.075
	50	--	--	20	B	3RF21 50-1AA26	1	1 unit	101	0.075
	70	--	--	28	B	3RF21 70-1AA26	1	1 unit	101	0.075
	90	--	--	36	B	3RF21 90-1AA26	1	1 unit	101	0.075
Instantaneous switching, rated operating voltage U_e 230 V ... 460 V										
Rated control supply voltage 24 V DC according to EN 61131-2										
	20	--	4.6	8	B	3RF21 20-1BA04	1	1 unit	101	0.075
	30	--	6.9	12	B	3RF21 30-1BA04	1	1 unit	101	0.075
	50	--	11.5	20	B	3RF21 50-1BA04	1	1 unit	101	0.075
	70	--	16.1	28	B	3RF21 70-1BA04	1	1 unit	101	0.075
	90	--	20.7	36	B	3RF21 90-1BA04	1	1 unit	101	0.075
Instantaneous switching, rated operating voltage U_e 400 V ... 600 V										
Rated control supply voltage 24 V DC according to EN 61131-2										
	50	--	--	20	B	3RF21 50-1BA06	1	1 unit	101	0.075

Other rated control supply voltages on request.

- 1) The type current provides information about the performance of the solid-state relay. The actual permitted rated operating current I_e can be smaller depending on the connection method and cooling conditions.
- 2) Please note that this version can only be used for a rated current of up to approx. 50 A and a conductor cross-section of 10 mm².

* You can order this quantity or a multiple thereof.

Solid-State Relays

3RF21 solid-state relays, 22.5 mm

Type current ¹⁾	Maximum achievable power for type current and			DT	Spring-loaded terminals ²⁾	PU (UNIT, SET, M)	PS*	PG	Weight per PU approx.
	$U_e = 115\text{ V}$	$U_e = 230\text{ V}$	$U_e = 400\text{ V}$						
A	kW	kW	kW		Order No.	Price per PU			kg
Zero-point switching, rated operating voltage U_e 24 V ... 230 V									
Rated control supply voltage 24 V DC according to EN 61131-2									
20	2.3	4.6	--	B	3RF21 20-2AA02		1	1 unit	101 0.075
50	5.8	11.5	--	B	3RF21 50-2AA02		1	1 unit	101 0.075
90	10.4	20.7	--	B	3RF21 90-2AA02		1	1 unit	101 0.075
Rated control supply voltage 110 ... 230 V AC									
20	2.3	4.6	--	B	3RF21 20-2AA22		1	1 unit	101 0.075
50	5.8	11.5	--	B	3RF21 50-2AA22		1	1 unit	101 0.075
90	10.4	20.7	--	B	3RF21 90-2AA22		1	1 unit	101 0.075
Zero-point switching, rated operating voltage U_e 230 V ... 460 V									
Rated control supply voltage 24 V DC according to EN 61131-2									
20	--	4.6	8	B	3RF21 20-2AA04		1	1 unit	101 0.075
50	--	11.5	20	B	3RF21 50-2AA04		1	1 unit	101 0.075
90	--	20.7	36	B	3RF21 90-2AA04		1	1 unit	101 0.075
Rated control supply voltage 110 ... 230 V AC									
20	--	4.6	8	B	3RF21 20-2AA24		1	1 unit	101 0.075
50	--	11.5	20	B	3RF21 50-2AA24		1	1 unit	101 0.075
90	--	20.7	36	B	3RF21 90-2AA24		1	1 unit	101 0.075
Zero-point switching, rated operating voltage U_e 400 V ... 600 V									
Rated control supply voltage 24 V DC according to EN 61131-2									
50	--	--	20	B	3RF21 50-2AA06		1	1 unit	101 0.075
90	--	--	36	B	3RF21 90-2AA06		1	1 unit	101 0.075
Rated control supply voltage 110 ... 230 V AC									
50	--	--	20	B	3RF21 50-2AA26		1	1 unit	101 0.075
90	--	--	36	B	3RF21 90-2AA26		1	1 unit	101 0.075

Other rated control supply voltages on request.

- 1) The type current provides information about the performance of the solid-state relays. The actual permitted rated operating current I_e can be smaller depending on the connection method and cooling conditions.
- 2) Please note that this version can only be used for a rated current of up to approx. 20 A and a conductor cross-section of 2.5 mm².

Solid-State Relays

3RF21 solid-state relays, 22.5 mm

Type current ¹⁾	Maximum achievable power for type current and			DT	Ring cable connection	PU (UNIT, SET, M)	PG	PS*	Weight per PU approx.
	$U_e = 115\text{ V}$	$U_e = 230\text{ V}$	$U_e = 400\text{ V}$						
A	kW	kW	kW		Order No.	Price per PU			kg
Zero-point switching, rated operating voltage U_e 24 V ... 230 V									
Rated control supply voltage 24 V DC according to EN 61131-2									
20	2.3	4.6	--	B	3RF21 20-3AA02		1	1 unit	101 0.075
50	5.8	11.5		B	3RF21 50-3AA02		1	1 unit	101 0.075
90	10.4	20.7		B	3RF21 90-3AA02		1	1 unit	101 0.075
Rated control supply voltage 110 ... 230 V AC									
20	2.3	4.6	--	B	3RF21 20-3AA22		1	1 unit	101 0.075
50	5.8	11.5		B	3RF21 50-3AA22		1	1 unit	101 0.075
90	10.4	20.7		B	3RF21 90-3AA22		1	1 unit	101 0.075
Zero-point switching, rated operating voltage U_e 230 V ... 460 V									
Rated control supply voltage 24 V DC according to EN 61131-2									
20	--	4.6	8	B	3RF21 20-3AA04		1	1 unit	101 0.075
50		11.5	20	B	3RF21 50-3AA04		1	1 unit	101 0.075
90		20.7	36	B	3RF21 90-3AA04		1	1 unit	101 0.075
Rated control supply voltage 110 ... 230 V AC									
20	--	4.6	8	B	3RF21 20-3AA24		1	1 unit	101 0.075
50		11.5	20	B	3RF21 50-3AA24		1	1 unit	101 0.075
90		20.7	36	B	3RF21 90-3AA24		1	1 unit	101 0.075
Rated control supply voltage 4 ... 30 V DC									
90	--	20.7	36	B	3RF21 90-3AA44		1	1 unit	101 0.075
Zero-point switching, rated operating voltage U_e 400 V ... 600 V									
Rated control supply voltage 24 V DC according to EN 61131-2									
50	--	--	20	B	3RF21 50-3AA06		1	1 unit	101 0.075
90			36	B	3RF21 90-3AA06		1	1 unit	101 0.075
Rated control supply voltage 110 ... 230 V AC									
50	--	--	20	B	3RF21 50-3AA26		1	1 unit	101 0.075
90			36	B	3RF21 90-3AA26		1	1 unit	101 0.075



3RF21 30-3AA02²⁾

Other rated control supply voltages on request.

1) The type current provides information about the performance of the solid-state relay. The actual permitted rated operating current I_e can be smaller depending on the connection method and cooling conditions.

2) Supplied without terminal covers.

Version	DT	Order No.	Price per PU	PU (UNIT, SET, M)	PS*	PG	Weight per PU approx.
Accessories							
		Screwdriver for spring-loaded connection system A		8WA2 880	1	1 unit	041 0.034
		Terminal cover for 3RF21 solid-state relays and 3RF23 solid-state contactors in ring terminal end (after simple adaptation, this terminal cover can also be used for screw connection).		3RF29 00-3PA88	1	10 units	101 0.004

3RF29 00-3PA88

* You can order this quantity or a multiple thereof.

Solid-State Relays

3RF20 solid-state relays, 45 mm

Selection and ordering data

Type current ¹⁾	Maximum achievable power for I_{max} and			DT	Screw connection ²⁾	PU (UNIT, SET, M)	PS*	PG	Weight per PU approx.
	$U_e = 115\text{ V}$	$U_e = 230\text{ V}$	$U_e = 400\text{ V}$						
A	kW	kW	kW						kg
Zero-point switching, rated operating voltage U_e 24 V ... 230 V									
Rated control supply voltage 24 V DC according to EN 61131-2									
20	2.3	4.6	--	A	3RF20 20-1AA02	1	1 unit	101	0.085
30	3.5	6.9	--	B	3RF20 30-1AA02	1	1 unit	101	0.085
50	5.8	11.5	--	A	3RF20 50-1AA02	1	1 unit	101	0.085
70	8.1	16.1	--	B	3RF20 70-1AA02	1	1 unit	101	0.085
90	10.4	20.7	--	B	3RF20 90-1AA02	1	1 unit	101	0.085
Rated control supply voltage 110 ... 230 V AC									
20	2.3	4.6	--	B	3RF20 20-1AA22	1	1 unit	101	0.085
30	3.5	6.9	--	B	3RF20 30-1AA22	1	1 unit	101	0.085
50	5.8	11.5	--	B	3RF20 50-1AA22	1	1 unit	101	0.085
70	8.1	16.1	--	B	3RF20 70-1AA22	1	1 unit	101	0.085
90	10.4	20.7	--	B	3RF20 90-1AA22	1	1 unit	101	0.085
Rated control supply voltage 4 ... 30 V DC									
20	2.3	4.6	--	B	3RF20 20-1AA42	1	1 unit	101	0.085
30	3.5	6.9	--	B	3RF20 30-1AA42	1	1 unit	101	0.085
Zero-point switching, rated operating voltage U_e 230 V ... 460 V									
Rated control supply voltage 24 V DC according to EN 61131-2									
20	--	4.6	8	A	3RF20 20-1AA04	1	1 unit	101	0.085
30	--	6.9	12	A	3RF20 30-1AA04	1	1 unit	101	0.085
50	--	11.5	20	A	3RF20 50-1AA04	1	1 unit	101	0.085
70	--	16.1	28	B	3RF20 70-1AA04	1	1 unit	101	0.085
90	--	20.7	36	A	3RF20 90-1AA04	1	1 unit	101	0.085
Rated control supply voltage 110 ... 230 V AC									
20	--	4.6	8	A	3RF20 20-1AA24	1	1 unit	101	0.085
30	--	6.9	12	B	3RF20 30-1AA24	1	1 unit	101	0.085
50	--	11.5	20	B	3RF20 50-1AA24	1	1 unit	101	0.085
70	--	16.1	28	B	3RF20 70-1AA24	1	1 unit	101	0.085
90	--	20.7	36	B	3RF20 90-1AA24	1	1 unit	101	0.085
Rated control supply voltage 4 ... 30 V DC									
50	--	11.5	20	B	3RF20 50-1AA44	1	1 unit	101	0.085
Zero-point switching, rated operating voltage U_e 48 V ... 600 V									
Rated control supply voltage 4 ... 30 V DC									
70	8.1	16.1	28	B	3RF20 70-1AA45	1	1 unit	101	0.085
Zero-point switching, rated operating voltage U_e 400 V ... 600 V									
Rated control supply voltage 24 V DC according to EN 61131-2									
30	--	--	12	B	3RF20 30-1AA06	1	1 unit	101	0.085
50	--	--	20	B	3RF20 50-1AA06	1	1 unit	101	0.085
70	--	--	28	B	3RF20 70-1AA06	1	1 unit	101	0.085
90	--	--	36	B	3RF20 90-1AA06	1	1 unit	101	0.085
Rated control supply voltage 110 ... 230 V AC									
30	--	--	12	B	3RF20 30-1AA26	1	1 unit	101	0.085
50	--	--	20	B	3RF20 50-1AA26	1	1 unit	101	0.085
70	--	--	28	B	3RF20 70-1AA26	1	1 unit	101	0.085
90	--	--	36	B	3RF20 90-1AA26	1	1 unit	101	0.085
Instantaneous switching, rated operating voltage U_e 230 V ... 460 V									
Rated control supply voltage 24 V DC according to EN 61131-2									
30	--	--	12	B	3RF20 30-1BA04	1	1 unit	101	0.085

1) The type current provides information about the performance of the solid-state relay. The actual permitted rated operating current I_e can be smaller depending on the connection method and cooling conditions.

2) Please note that this version can only be used for a rated current of up to 50 A and a conductor cross-section of 10 mm².

Solid-State Contactors

General data

Overview

The complete units consist of a solid-state relay plus optimized heat sink, and are therefore "ready to use". They offer defined rated currents to make selection as easy as possible. Depending on the version, current intensities of up to 88 A are achieved. Like all of our solid-state switching devices, one of their particular advantages is their compact and space-saving design. With their insulated mounting foot they can easily be snapped onto a standard mounting rail, or they can be mounted on carrier plates with fixing screws. This insulation enables them to be used in circuits with protective extra-low voltage (PELV) or safety extra-low voltage (SELV) in building engineering. For other applications, such as for extended personal safety, the heat sink can be grounded through a screw connection.

Version for resistive loads, "Zero-point switching"

This standard version is often used for switching space heaters on and off.

Version for inductive loads, "Instantaneous switching"

In this version the solid-state contactor is specifically matched to inductive loads. Whether it is a matter of frequent actuation of the valves in a filling plant or starting and stopping small drives in packet distribution systems, operation is carried out safely and noiselessly.

Special "low noise" version

Thanks to a special control circuit, this special design can be used in public networks up to 16 A without any additional measures such as interference suppressor filters. As a result it conforms to limit value curve class B in accordance with EN 60947-4-3 in terms of emitted interference.

Special "Short-circuit-resistant" version

Skilful matching of the power semiconductor with the performance of the solid-state contactor means that "short-circuit strength" can be achieved with a standard miniature circuit-breaker. In combination with a B-type MCB or a conventional fuse, the result is a short-circuit resistant feeder.

In order to achieve problem-free short-circuit protection by means of miniature circuit-breakers, however, certain boundary conditions must be observed. As the magnitude and duration of the short-circuit current are determined not only by the short circuit breaking response of the miniature circuit-breaker but also the properties of the wiring system, such as the internal resistance of the input to the network and damping by switching devices and cables, particular attention must also be paid to these parameters. The necessary cable lengths are therefore shown for the main factor, the conductor resistance, in the table below.

The following miniature circuit-breakers with a type B tripping characteristic and 10 kA or 6 kA breaking capacity protect the 3RF23...DA... solid-state contactors in the event of short-circuits on the load and the specified conductor cross-sections and lengths:

Rated current of the miniature circuit-breaker	Example Type ¹⁾	Max. conductor cross-section	Cable length from contactor to load
6 A	5SY4 106-6, 5SX2 106-6	1 mm ²	5 m
10 A	5SY4 110-6, 5SX2 110-6	1.5 mm ²	8 m
16 A	5SY4 116-6, 5SX2 116-6	1.5 mm ²	12 m
16 A	5SY4 116-6, 5SX2 116-6	2.5 mm ²	20 m
20 A	5SY4 120-6, 5SX2 120-6	2.5 mm ²	20 m
25 A	5SY4 125-6, 5SX2 125-6	2.5 mm ²	26 m

1) The miniature circuit-breakers can be used up to a maximum rated voltage of 480 V.

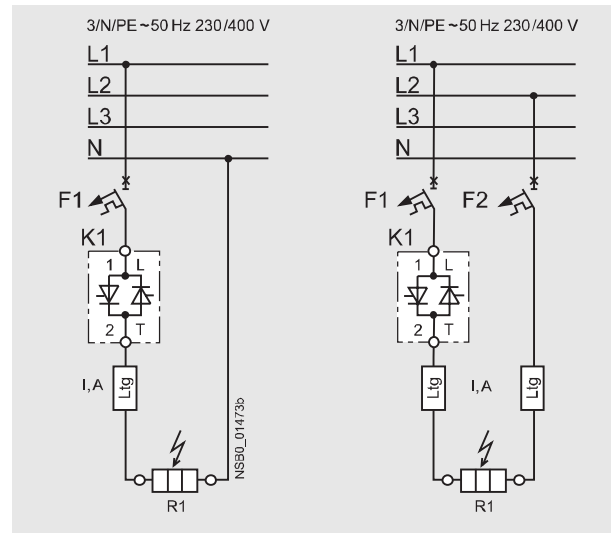

The setup and installation above can also be used for the solid-state relays with a I^2t value of at least 6600 A²s.

More information

Selecting solid-state contactors

The solid-state contactors are selected on the basis of details of the power system, the load and the ambient conditions. As the solid-state contactors are already equipped with an optimally matched heat sink, the selection process is considerably simpler than that for solid-state relays.



The following procedure is recommended:

- Determine the rated current of the load and the mains voltage
- Select a solid-state contactor with the same or higher rated current than the load
- Check the correct contactor size with the aid of the rated current diagram, taking account of the design conditions

Solid-State Contactors

3RF23 solid-state contactors

Selection and ordering data

Type current ¹⁾ I_{max}	Rated power at I_{max} and			DT	Screw connection	PU (UNIT, SET, M)	PS*	PG	Weight per PU approx.	
	$U_e = 115\text{ V}$	$U_e = 230\text{ V}$	$U_e = 400\text{ V}$							
A	kW	kW	kW		Order No.	Price per PU			kg	
Zero-point switching, rated operating voltage U_e 24 V ... 230 V										
Rated control supply voltage 24 V DC according to EN 61131-2										
	10.5	1.2	2.4	--	A	3RF23 10-1AA02	1	1 unit	101	0.165
	20	2.3	4.6	--	A	3RF23 20-1AA02	1	1 unit	101	0.240
	30	3.5	6.9	--	A	3RF23 30-1AA02	1	1 unit	101	0.400
	40	4.6	9.2	--	A	3RF23 40-1AA02	1	1 unit	101	0.550
	50	6	12	--	A	3RF23 50-1AA02	1	1 unit	101	0.550
Rated control supply voltage 24 V AC/DC										
	10.5	1.2	2.4	--	B	3RF23 10-1AA12	1	1 unit	101	0.165
Rated control supply voltage 110 ... 230 V AC										
3RF23 10-1	10.5	1.2	2.4	--	A	3RF23 10-1AA22	1	1 unit	101	0.165
	20	2.3	4.6	--	A	3RF23 20-1AA22	1	1 unit	101	0.240
	30	3.5	6.9	--	A	3RF23 30-1AA22	1	1 unit	101	0.400
	40	4.6	9.2	--	B	3RF23 40-1AA22	1	1 unit	101	0.550
	50	6	12	--	B	3RF23 50-1AA22	1	1 unit	101	0.550
Zero-point switching, rated operating voltage U_e 230 V ... 460 V										
Rated control supply voltage 24 V DC according to EN 61131-2										
	10.5	--	2.4	4.2	A	3RF23 10-1AA04	1	1 unit	101	0.165
	20	--	4.6	8	A	3RF23 20-1AA04	1	1 unit	101	0.240
	30	--	6.9	12	A	3RF23 30-1AA04	1	1 unit	101	0.400
	40	--	9.2	16	A	3RF23 40-1AA04	1	1 unit	101	0.550
	50	--	12	20	A	3RF23 50-1AA04	1	1 unit	101	0.550
Rated control supply voltage 24 V AC/DC										
	20	--	4.6	8	B	3RF23 20-1AA14	1	1 unit	101	0.240
	30	--	6.9	12	B	3RF23 30-1AA14	1	1 unit	101	0.400
Rated control supply voltage 110 ... 230 V AC										
3RF23 20-1	10.5	--	2.4	4.2	A	3RF23 10-1AA24	1	1 unit	101	0.165
	20	--	4.6	8	A	3RF23 20-1AA24	1	1 unit	101	0.240
	30	--	6.9	12	A	3RF23 30-1AA24	1	1 unit	101	0.400
	40	--	9.2	16	A	3RF23 40-1AA24	1	1 unit	101	0.550
	50	--	12	20	A	3RF23 50-1AA24	1	1 unit	101	0.550
Rated control supply voltage 4 ... 30 V DC										
	10.5	--	2.4	4.2	B	3RF23 10-1AA44	1	1 unit	101	0.165
	20	--	4.6	8	B	3RF23 20-1AA44	1	1 unit	101	0.240
	30	--	6.9	12	B	3RF23 30-1AA44	1	1 unit	101	0.400
Zero-point switching, rated operating voltage U_e 48 V ... 600 V										
Rated control supply voltage 4 ... 30 V DC										
	20	2.3	4.6	8	B	3RF23 20-1AA45	1	1 unit	101	0.240
	40	4.6	9.2	16	A	3RF23 40-1AA45	1	1 unit	101	0.550
	50	6	12	20	A	3RF23 50-1AA45	1	1 unit	101	0.550
Zero-point switching, rated operating voltage U_e 400 V ... 600 V										
Rated control supply voltage 24 V DC according to EN 61131-2										
	10.5	--	--	4.2	B	3RF23 10-1AA06	1	1 unit	101	0.165
	20	--	--	8	B	3RF23 20-1AA06	1	1 unit	101	0.240
	30	--	--	12	B	3RF23 30-1AA06	1	1 unit	101	0.400
	40	--	--	16	B	3RF23 40-1AA06	1	1 unit	101	0.550
	50	--	--	20	B	3RF23 50-1AA06	1	1 unit	101	0.550
Rated control supply voltage 110 ... 230 V AC										
3RF23 40-1	10.5	--	--	4.2	B	3RF23 10-1AA26	1	1 unit	101	0.165
	20	--	--	8	B	3RF23 20-1AA26	1	1 unit	101	0.240
	30	--	--	12	B	3RF23 30-1AA26	1	1 unit	101	0.400
	40	--	--	16	B	3RF23 40-1AA26	1	1 unit	101	0.550
	50	--	--	20	B	3RF23 50-1AA26	1	1 unit	101	0.550

Other rated control supply voltages on request.

1) The type current provides information about the performance of the solid-state contactor. The actual permitted rated operating current I_e can be smaller depending on the connection method and start-up conditions. For derating, see Technical Information LV 1 T, Characteristic Curves.

Solid-State Contactors

3RF23 solid-state contactors

Type current ¹⁾ I_{max}	Rated power at I_{max} and			DT	Screw connection	PU (UNIT, SET, M)	PS*	PG	Weight per PU approx.	
	$U_e = 115\text{ V}$	$U_e = 230\text{ V}$	$U_e = 400\text{ V}$							
A	kW	kW	kW		Order No.	Price per PU			kg	
Instantaneous switching, rated operating voltage U_e 24 V ... 230 V										
Rated control supply voltage 24 V DC according to EN 61131-2										
	10.5	1.2	2.4	--	B	3RF23 10-1BA02	1	1 unit	101	0.165
	20	2.3	4.6		B	3RF23 20-1BA02	1	1 unit	101	0.240
	30	3.5	6.9		B	3RF23 30-1BA02	1	1 unit	101	0.400
	40	4.6	9.2		B	3RF23 40-1BA02	1	1 unit	101	0.550
	50	6	12		B	3RF23 50-1BA02	1	1 unit	101	0.550
	70	8	16		B	3RF23 70-1BA02	1	1 unit	101	1.200
	88	10	21		B	3RF23 90-1BA02	1	1 unit	101	2.900
Rated control supply voltage 110 ... 230 V AC										
	10.5	1.2	2.4	--	B	3RF23 10-1BA22	1	1 unit	101	0.165
	20	2.3	4.6		B	3RF23 20-1BA22	1	1 unit	101	0.240
	30	3.5	6.9		B	3RF23 30-1BA22	1	1 unit	101	0.400
	40	4.6	9.2		B	3RF23 40-1BA22	1	1 unit	101	0.550
	50	6	12		B	3RF23 50-1BA22	1	1 unit	101	0.550
	70	8	16		B	3RF23 70-1BA22	1	1 unit	101	1.200
	88	10	21		B	3RF23 90-1BA22	1	1 unit	101	2.900
Instantaneous switching, rated operating voltage U_e 230 V ... 460 V										
Rated control supply voltage 24 V DC according to EN 61131-2										
	10.5	--	2.4	4.2	B	3RF23 10-1BA04	1	1 unit	101	0.165
	20		4.6	8	B	3RF23 20-1BA04	1	1 unit	101	0.240
	30		6.9	12	B	3RF23 30-1BA04	1	1 unit	101	0.400
	40		9.2	16	B	3RF23 40-1BA04	1	1 unit	101	0.550
	50		12	20	B	3RF23 50-1BA04	1	1 unit	101	0.550
	70		16	28	B	3RF23 70-1BA04	1	1 unit	101	1.200
	88		21	36	B	3RF23 90-1BA04	1	1 unit	101	2.900
Rated control supply voltage 110 ... 230 V AC										
	10.5	--	2.4	4.2	B	3RF23 10-1BA24	1	1 unit	101	0.165
	20		4.6	8	B	3RF23 20-1BA24	1	1 unit	101	0.240
	30		6.9	12	B	3RF23 30-1BA24	1	1 unit	101	0.400
	40		9.2	16	B	3RF23 40-1BA24	1	1 unit	101	0.550
	50		12	20	B	3RF23 50-1BA24	1	1 unit	101	0.550
	70		16	28	B	3RF23 70-1BA24	1	1 unit	101	1.200
	88		21	36	B	3RF23 90-1BA24	1	1 unit	101	2.900
Rated control supply voltage 4 ... 30 V DC										
	30	--	6.9	12	B	3RF23 30-1BA44	1	1 unit	101	0.400
	50		12	20	B	3RF23 50-1BA44	1	1 unit	101	0.550
Instantaneous switching, rated operating voltage U_e 400 V ... 600 V										
Rated control supply voltage 24 V DC according to EN 61131-2										
	10.5	--	--	4.2	B	3RF23 10-1BA06	1	1 unit	101	0.165
	20			8	B	3RF23 20-1BA06	1	1 unit	101	0.240
	30			12	B	3RF23 30-1BA06	1	1 unit	101	0.400
	40			16	B	3RF23 40-1BA06	1	1 unit	101	0.550
	50			20	B	3RF23 50-1BA06	1	1 unit	101	0.550
	70			28	B	3RF23 70-1BA06	1	1 unit	101	1.200
	88			36	B	3RF23 90-1BA06	1	1 unit	101	2.900
Rated control supply voltage 110 ... 230 V AC										
	10.5	--	--	4.2	B	3RF23 10-1BA26	1	1 unit	101	0.165
	20			8	B	3RF23 20-1BA26	1	1 unit	101	0.240
	30			12	B	3RF23 30-1BA26	1	1 unit	101	0.400
	40			16	B	3RF23 40-1BA26	1	1 unit	101	0.550
	50			20	B	3RF23 50-1BA26	1	1 unit	101	0.550
	70			28	B	3RF23 70-1BA26	1	1 unit	101	1.200
	88			36	B	3RF23 90-1BA26	1	1 unit	101	2.900

Other rated control supply voltages on request.

1) The type current provides information about the performance of the solid-state contactor. The actual permitted rated operating current I_e can be smaller depending on the connection method and start-up conditions. For derating, see Technical Information LV 1 T, Characteristic Curves.

* You can order this quantity or a multiple thereof.

Solid-State Contactors

3RF23 solid-state contactors

Type current ¹⁾ I_{max}	Rated control supply voltage U_s	Rated power at I_{max} and $U_e = 115\text{ V}$ $U_e = 230\text{ V}$ $U_e = 400\text{ V}$			DT	Screw connection	PU (UNIT, SET, M)	PS*	PG	Weight per PU approx.
		kW	kW	kW						
Low noise, rated operating voltage U_e 24 V ... 230 V										
20	24 V DC acc. to EN 61131-2	2.3	4.6	--	B	3RF23 20-1CA02	1	1 unit	101	0.240
30	EN 61131-2	3.5	6.9	--	B	3RF23 30-1CA02	1	1 unit	101	0.400
20	110 V ... 230 V AC	2.3	4.6	--	B	3RF23 20-1CA22	1	1 unit	101	0.240
Low noise, rated operating voltage U_e 230 V ... 460 V										
20	24 V DC acc. to EN 61131-2	--	4.6	8	B	3RF23 20-1CA04	1	1 unit	101	0.240
20	110 V ... 230 V AC	--	4.6	8	B	3RF23 20-1CA24	1	1 unit	101	0.240
20	4 V ... 30 V DC	--	4.6	8	A	3RF23 20-1CA44	1	1 unit	101	0.240
Short-circuit resistant with B-automatic device, rated operating voltage U_e 24 V ... 230 V										
20	24 V DC acc. to EN 61131-2	2.3	4.6	--	B	3RF23 20-1DA02	1	1 unit	101	0.240
20	110 V ... 230 V AC	2.3	4.6	--	B	3RF23 20-1DA22	1	1 unit	101	0.240
Short-circuit resistant with B-automatic device, rated operating voltage U_e 230 V ... 460 V										
20	24 V DC acc. to EN 61131-2	--	4.6	8	B	3RF23 20-1DA04	1	1 unit	101	0.240
20	110 V ... 230 V AC	--	4.6	8	B	3RF23 20-1DA24	1	1 unit	101	0.240
20	4 V ... 30 V DC	--	4.6	8	B	3RF23 20-1DA44	1	1 unit	101	0.240
30			6.9	12	B	3RF23 30-1DA44	1	1 unit	101	0.240

Other rated control supply voltages on request.

1) The type current provides information about the performance of the solid-state contactor. The actual permitted rated operating current I_e can be smaller depending on the connection method and start-up conditions. For derating, see Technical Information LV 1 T, Characteristic Curves.

Type current ¹⁾ I_{max}	Rated control supply voltage U_s	Rated power at I_{max} and $U_e = 115\text{ V}$ $U_e = 230\text{ V}$ $U_e = 400\text{ V}$			DT	Spring-loaded terminals	PU (UNIT, SET, M)	PS*	PG	Weight per PU approx.
		kW	kW	kW						
Zero-point switching, rated operating voltage U_e 24 V ... 230 V										
10.5	24 V DC acc. to EN 61131-2	1.2	2.4	--	B	3RF23 10-2AA02	1	1 unit	101	0.166
20		2.3	4.6	--	B	3RF23 20-2AA02	1	1 unit	101	0.240
10.5	110 V ... 230 V AC	1.2	2.4	--	B	3RF23 10-2AA22	1	1 unit	101	0.166
20		2.3	4.6	--	B	3RF23 20-2AA22	1	1 unit	101	0.240
Zero-point switching, rated operating voltage U_e 230 V ... 460 V										
10.5	24 V DC acc. to EN 61131-2	--	2.4	4.2	B	3RF23 10-2AA04	1	1 unit	101	0.166
20			4.6	8	B	3RF23 20-2AA04	1	1 unit	101	0.240
10.5	110 V ... 230 V AC	--	2.4	4.2	B	3RF23 10-2AA24	1	1 unit	101	0.166
20			4.6	8	B	3RF23 20-2AA24	1	1 unit	101	0.240
Zero-point switching, rated operating voltage U_e 400 V ... 600 V										
10.5	24 V DC acc. to EN 61131-2	--	--	4.2	B	3RF23 10-2AA06	1	1 unit	101	0.166
20				8	B	3RF23 20-2AA06	1	1 unit	101	0.240
10.5	110 V ... 230 V AC	--	--	4.2	B	3RF23 10-2AA26	1	1 unit	101	0.166
20				8	B	3RF23 20-2AA26	1	1 unit	101	0.240
Low noise, rated operating voltage U_e 24 V ... 230 V										
20	24 V DC acc. to EN 61131-2	2.3	4.6	--	B	3RF23 20-2CA02	1	1 unit	101	0.240
20	110 V ... 230 V AC	2.3	4.6	--	B	3RF23 20-2CA22	1	1 unit	101	0.240
Low noise, rated operating voltage U_e 230 V ... 460 V										
20	24 V DC acc. to EN 61131-2	--	4.6	8	B	3RF23 20-2CA04	1	1 unit	101	0.240
20	110 V ... 230 V AC	--	4.6	8	B	3RF23 20-2CA24	1	1 unit	101	0.240
Short-circuit resistant with B-automatic device, rated operating voltage U_e 24 V ... 230 V										
20	110 V ... 230 V AC	2.3	4.6	--	B	3RF23 20-2DA22	1	1 unit	101	0.240
Short-circuit resistant with B-automatic device, rated operating voltage U_e 230 V ... 460 V										
20	110 V ... 230 V AC	--	4.6	8	B	3RF23 20-2DA24	1	1 unit	101	0.240

Other rated control supply voltages on request.

1) The type current provides information about the performance of the solid-state contactor. The actual permitted rated operating current I_e can be smaller depending on the connection method and start-up conditions. For derating, see Technical Information LV 1 T, Characteristic Curves.

Solid-State Contactors

3RF23 solid-state contactors

Type current ¹⁾ I_{max}	Rated power at I_{max} and			DT	Ring cable connection	PU (UNIT, SET, M)	PS*	PG	Weight per PU approx.		
	$U_e = 115\text{ V}$	$U_e = 230\text{ V}$	$U_e = 400\text{ V}$								
A	kW	kW	kW		Order No.	Price per PU			kg		
Zero-point switching, rated operating voltage U_e 24 V ... 230 V											
Rated control supply voltage 24 V DC acc. to EN 61131-2											
	10.5	1.2	2.4	--	B	3RF23 10-3AA02		1	1 unit	101	0.166
	20	2.3	4.6	--	B	3RF23 20-3AA02		1	1 unit	101	0.200
	30	3.5	6.9	--	B	3RF23 30-3AA02		1	1 unit	101	0.435
	40	4.6	9.2	--	B	3RF23 40-3AA02		1	1 unit	101	0.550
	50	6	12	--	B	3RF23 50-3AA02		1	1 unit	101	0.550
	70	8	16	--	B	3RF23 70-3AA02		1	1 unit	101	1.200
	88	10	21	--	B	3RF23 90-3AA02		1	1 unit	101	2.900
Rated control supply voltage 110 ... 230 V AC											
	10.5	1.2	2.4	--	B	3RF23 10-3AA22		1	1 unit	101	0.166
	20	2.3	4.6	--	B	3RF23 20-3AA22		1	1 unit	101	0.200
	30	3.5	6.9	--	B	3RF23 30-3AA22		1	1 unit	101	0.435
	40	4.6	9.2	--	B	3RF23 40-3AA22		1	1 unit	101	0.550
	50	6	12	--	B	3RF23 50-3AA22		1	1 unit	101	0.550
	70	8	16	--	B	3RF23 70-3AA22		1	1 unit	101	1.200
	88	10	21	--	B	3RF23 90-3AA22		1	1 unit	101	2.900
Zero-point switching, rated operating voltage U_e 230 V ... 460 V											
Rated control supply voltage 24 V DC acc. to EN 61131-2											
	10.5	--	2.4	4.2	B	3RF23 10-3AA04		1	1 unit	101	0.166
	20	--	4.6	8	B	3RF23 20-3AA04		1	1 unit	101	0.200
	30	--	6.9	12	B	3RF23 30-3AA04		1	1 unit	101	0.435
	40	--	9.2	16	B	3RF23 40-3AA04		1	1 unit	101	0.550
	50	--	12	20	B	3RF23 50-3AA04		1	1 unit	101	0.550
	70	--	16	28	A	3RF23 70-3AA04		1	1 unit	101	1.200
	88	--	21	36	B	3RF23 90-3AA04		1	1 unit	101	2.900
Rated control supply voltage 110 ... 230 V AC											
	10.5	--	2.4	4.2	B	3RF23 10-3AA24		1	1 unit	101	0.166
	20	--	4.6	8	B	3RF23 20-3AA24		1	1 unit	101	0.200
	30	--	6.9	12	B	3RF23 30-3AA24		1	1 unit	101	0.435
	40	--	9.2	16	B	3RF23 40-3AA24		1	1 unit	101	0.550
	50	--	12	20	B	3RF23 50-3AA24		1	1 unit	101	0.550
	70	--	16	28	B	3RF23 70-3AA24		1	1 unit	101	1.200
	88	--	21	36	B	3RF23 90-3AA24		1	1 unit	101	2.900
Rated control supply voltage 4 ... 30 V DC											
	20	--	4.6	8	B	3RF23 20-3AA44		1	1 unit	101	0.200
	30	--	6.9	12	B	3RF23 30-3AA44		1	1 unit	101	0.435
	50	--	12	20	B	3RF23 50-3AA44		1	1 unit	101	0.550
Zero-point switching, rated operating voltage U_e 48 V ... 600 V											
Rated control supply voltage 4 ... 30 V DC											
	40	4.6	9.2	16	B	3RF23 40-3AA45		1	1 unit	101	0.550
	70	8	16	28	B	3RF23 70-3AA45		1	1 unit	101	1.200
	88	10	21	36	B	3RF23 90-3AA45		1	1 unit	101	2.900
Zero-point switching, rated operating voltage U_e 400 V ... 600 V											
Rated control supply voltage 24 V DC acc. to EN 61131-2											
	10.5	--	--	4.2	B	3RF23 10-3AA06		1	1 unit	101	0.166
	20	--	--	8	B	3RF23 20-3AA06		1	1 unit	101	0.200
	30	--	--	12	B	3RF23 30-3AA06		1	1 unit	101	0.435
	40	--	--	16	B	3RF23 40-3AA06		1	1 unit	101	0.550
	50	--	--	20	B	3RF23 50-3AA06		1	1 unit	101	0.550
	70	--	--	28	B	3RF23 70-3AA06		1	1 unit	101	1.200
	88	--	--	36	B	3RF23 90-3AA06		1	1 unit	101	2.900
Rated control supply voltage 110 ... 230 V AC											
	10.5	--	--	4.2	B	3RF23 10-3AA26		1	1 unit	101	0.166
	20	--	--	8	B	3RF23 20-3AA26		1	1 unit	101	0.200
	30	--	--	12	B	3RF23 30-3AA26		1	1 unit	101	0.435
	40	--	--	16	B	3RF23 40-3AA26		1	1 unit	101	0.550
	50	--	--	20	B	3RF23 50-3AA26		1	1 unit	101	0.550
	70	--	--	28	B	3RF23 70-3AA26		1	1 unit	101	1.200
	88	--	--	36	B	3RF23 90-3AA26		1	1 unit	101	2.900

Other rated control supply voltages on request.

- 1) The type current provides information about the performance of the solid-state contactor. The actual permitted rated operating current I_e can be smaller depending on the connection method and start-up conditions. For derating, see Technical Information LV 1 T, Characteristic Curves.
- 2) Supplied without terminal covers.

* You can order this quantity or a multiple thereof.

Solid-State Contactors

3RF23 solid-state contactors

Type current ¹⁾ I_{max}	Rated control supply voltage U_s	Rated power at I_{max} and			DT	Ring cable connection	PU (UNIT, SET, M)	PS*	PG	Weight per PU approx. kg	
		$U_e = 115 V$	$U_e = 230 V$	$U_e = 400 V$							
A		kW	kW	kW		Order No.	Price per PU				
Instantaneous switching, rated operating voltage U_e 24 V ... 230 V											
70	24 V DC acc. to EN 61131-2	8	16	--	B	3RF23 70-3BA02		1	1 unit	101	1.200
88		10	21	--	B	3RF23 90-3BA02		1	1 unit	101	2.900
70	110 V ... 230 V AC	8	16	--	B	3RF23 70-3BA22		1	1 unit	101	1.200
88		10	21	--	B	3RF23 90-3BA22		1	1 unit	101	2.900
Instantaneous switching, rated operating voltage U_e 230 V ... 460 V											
70	24 V DC acc. to EN 61131-2	--	16	28	B	3RF23 70-3BA04		1	1 unit	101	1.200
88		--	21	36	B	3RF23 90-3BA04		1	1 unit	101	2.900
70	110 V ... 230 V AC	--	16	28	B	3RF23 70-3BA24		1	1 unit	101	1.200
88		--	21	36	B	3RF23 90-3BA24		1	1 unit	101	2.900
Instantaneous switching, rated operating voltage U_e 400 V ... 600 V											
70	24 V DC acc. to EN 61131-2	--	--	28	B	3RF23 70-3BA06		1	1 unit	101	1.200
88		--	--	36	B	3RF23 90-3BA06		1	1 unit	101	2.900
70	110 V ... 230 V AC	--	--	28	B	3RF23 70-3BA26		1	1 unit	101	1.200
88		--	--	36	B	3RF23 90-3BA26		1	1 unit	101	2.900
Short-circuit resistant with B-automatic device, rated operating voltage U_e 24 V ... 230 V											
20	24 V DC acc. to EN 61131-2	2.3	4.6	--	B	3RF23 20-3DA02		1	1 unit	101	0.200
20	110 V ... 230 V AC	2.3	4.6	--	B	3RF23 20-3DA22		1	1 unit	101	0.200
Short-circuit resistant with B-automatic device, rated operating voltage U_e 230 V ... 460 V											
20	24 V DC acc. to EN 61131-2	--	4.6	8	B	3RF23 20-3DA04		1	1 unit	101	0.200
20	110 V ... 230 V AC	--	4.6	8	B	3RF23 20-3DA24		1	1 unit	101	0.200

Other rated control supply voltages on request.

1) The type current provides information about the performance of the solid-state contactor. The actual permitted rated operating current I_e can be smaller depending on the connection method and start-up conditions. For derating, see Technical Information LV 1 T, Characteristic Curves.

Version	DT	Order No.	Price per PU	PU (UNIT, SET, M)	PS*	PG	Weight per PU approx. kg
Accessories							
	A	Screwdriver for spring-loaded connection system	8WA2 880	1	1 unit	041	0.034
	A	Terminal cover for 3RF21 solid-state relays and 3RF23 solid-state contactors with ring terminal end (after simple adaptation, this terminal cover can also be used for screw connection)	3RF29 00-3PA88	1	10 units	101	0.004

3RF29 00-3PA88

3RF29 Function Modules

General data

Overview

Function modules for SIRIUS SC solid-state switching devices

A great variety of applications demand an expanded range of functionality. With our function modules, these requirements can be met really easily. The modules are mounted simply by clicking them into place; straight away the necessary connections are made with the solid-state relay or contactor.

The plug-in connection to control the solid-state switching devices can simply remain in use.

The following function modules are available:

- Converters
- Load monitoring
- Heating current monitoring
- Power controllers

Assignment of the function modules to the 3RF21 relays

Order No.	Accessories				
	Converters	Load monitoring Basic	Extended	Heating current monitoring	Power controllers
Type current = 20 A					
3RF21 2.-1A.02	3RF2900-OEA18	3RF2920-OFA08	3RF2920-OGA13	--	--
3RF21 2.-1A.04	3RF2900-OEA18	3RF2920-OFA08	3RF2920-OGA16	3RF2932-OJA16	--
3RF21 2.-1A.22	--	--	3RF2920-OGA33	--	--
3RF21 2.-1A.24	--	--	3RF2920-OGA36	--	--
3RF21 2.-1A.42	--	--	--	--	--
3RF21 2.-1B.04	3RF2900-OEA18	3RF2920-OFA08	3RF2920-OGA16	3RF2932-OJA16	3RF2920-OHA16
3RF21 2.-2A.02	3RF2900-OEA18	--	--	--	--
3RF21 2.-2A.04	3RF2900-OEA18	--	--	--	--
3RF21 2.-2A.22	--	--	--	--	--
3RF21 2.-2A.24	--	--	--	--	--
3RF21 2.-3A.02	3RF2900-OEA18	--	3RF2920-OGA13	--	--
3RF21 2.-3A.04	3RF2900-OEA18	--	3RF2920-OGA16	3RF2932-OJA16	--
3RF21 2.-3A.22	--	--	3RF2920-OGA33	--	--
3RF21 2.-3A.24	--	--	3RF2920-OGA36	--	--
Type current = 30 A					
3RF21 3.-1A.02	3RF2900-OEA18	3RF2920-OFA08	3RF2950-OGA13	--	--
3RF21 3.-1A.04	3RF2900-OEA18	3RF2920-OFA08	3RF2950-OGA16	3RF2932-OJA16	--
3RF21 3.-1A.06	3RF2900-OEA18	3RF2920-OFA08	3RF2950-OGA16	3RF2932-OJA16	--
3RF21 3.-1A.22	--	--	3RF2950-OGA33	--	--
3RF21 3.-1A.24	--	--	3RF2950-OGA36	--	--
3RF21 3.-1A.26	--	--	3RF2950-OGA36	--	--
3RF21 3.-1A.42	3RF2900-OEA18	3RF2920-OFA08	3RF2950-OGA13	--	--
3RF21 3.-1B.04	3RF2900-OEA18	3RF2920-OFA08	3RF2950-OGA16	3RF2932-OJA16	3RF2950-OHA16
Type current = 50 A					
3RF21 5.-1A.02	3RF2900-OEA18	3RF2920-OFA08	3RF2950-OGA13	--	--
3RF21 5.-1A.04	3RF2900-OEA18	3RF2920-OFA08	3RF2950-OGA16	3RF2932-OJA16	--
3RF21 5.-1A.06	3RF2900-OEA18	3RF2920-OFA08	3RF2950-OGA16	3RF2932-OJA16	--
3RF21 5.-1A.22	--	--	3RF2950-OGA33	--	--
3RF21 5.-1A.24	--	--	3RF2950-OGA36	--	--
3RF21 5.-1A.26	--	--	3RF2950-OGA36	--	--
3RF21 5.-1B.04	3RF2900-OEA18	3RF2920-OFA08	3RF2950-OGA16	3RF2932-OJA16	3RF2950-OHA16
3RF21 5.-1B.06	3RF2900-OEA18	3RF2920-OFA08	3RF2950-OGA16	3RF2932-OJA16	3RF2950-OHA16
3RF21 5.-2A.02	3RF2900-OEA18	--	--	--	--
3RF21 5.-2A.04	3RF2900-OEA18	--	--	--	--
3RF21 5.-2A.06	3RF2900-OEA18	--	--	--	--
3RF21 5.-2A.22	--	--	--	--	--
3RF21 5.-2A.24	--	--	--	--	--
3RF21 5.-2A.26	--	--	--	--	--
3RF21 5.-3A.02	3RF2900-OEA18	--	3RF2950-OGA13	--	--
3RF21 5.-3A.04	3RF2900-OEA18	--	3RF2950-OGA16	3RF2932-OJA16	--
3RF21 5.-3A.06	3RF2900-OEA18	--	3RF2950-OGA16	3RF2932-OJA16	--
3RF21 5.-3A.22	--	--	3RF2950-OGA33	--	--
3RF21 5.-3A.24	--	--	3RF2950-OGA36	--	--
3RF21 5.-3A.26	--	--	3RF2950-OGA36	--	--

3RF29 Function Modules

General data

Order No.	Accessories				
	Converters	Load monitoring Basic	Extended	Heating current monitoring	Power controllers
Type current = 70 A					
3RF21 7.-1A.02	3RF2900-0EA18	3RF2920-0FA08	3RF2990-0GA13	--	--
3RF21 7.-1A.04	3RF2900-0EA18	3RF2920-0FA08	3RF2990-0GA16	3RF2932-0JA16	--
3RF21 7.-1A.06	3RF2900-0EA18	3RF2920-0FA08	3RF2990-0GA16	3RF2932-0JA16	--
3RF21 7.-1A.22	--	--	3RF2990-0GA33	--	--
3RF21 7.-1A.24	--	--	3RF2990-0GA36	--	--
3RF21 7.-1A.26	--	--	3RF2990-0GA36	--	--
3RF21 7.-1A.45	3RF2900-0EA18	3RF2920-0FA08	3RF2990-0GA16	3RF2932-0JA16	--
3RF21 7.-1B.04	3RF2900-0EA18	3RF2920-0FA08	3RF2990-0GA16	3RF2932-0JA16	3RF2990-0HA16
Type current = 90 A					
3RF21 9.-1A.02	3RF2900-0EA18	3RF2920-0FA08	3RF2990-0GA13	--	--
3RF21 9.-1A.04	3RF2900-0EA18	3RF2920-0FA08	3RF2990-0GA16	3RF2932-0JA16	--
3RF21 9.-1A.06	3RF2900-0EA18	3RF2920-0FA08	3RF2990-0GA16	3RF2932-0JA16	--
3RF21 9.-1A.22	--	--	3RF2990-0GA33	--	--
3RF21 9.-1A.24	--	--	3RF2990-0GA36	--	--
3RF21 9.-1A.26	--	--	3RF2990-0GA36	--	--
3RF21 9.-1B.04	3RF2900-0EA18	3RF2920-0FA08	3RF2990-0GA16	3RF2932-0JA16	3RF2990-0HA16
3RF21 9.-2A.02	3RF2900-0EA18	--	--	--	--
3RF21 9.-2A.04	3RF2900-0EA18	--	--	--	--
3RF21 9.-2A.06	3RF2900-0EA18	--	--	--	--
3RF21 9.-2A.22	--	--	--	--	--
3RF21 9.-2A.24	--	--	--	--	--
3RF21 9.-2A.26	--	--	--	--	--
3RF21 9.-3A.02	3RF2900-0EA18	--	3RF2990-0GA13	--	--
3RF21 9.-3A.04	3RF2900-0EA18	--	3RF2990-0GA16	3RF2932-0JA16	--
3RF21 9.-3A.06	3RF2900-0EA18	--	3RF2990-0GA16	3RF2932-0JA16	--
3RF21 9.-3A.22	--	--	3RF2990-0GA33	--	--
3RF21 9.-3A.24	--	--	3RF2990-0GA36	--	--
3RF21 9.-3A.26	--	--	3RF2990-0GA36	--	--
3RF21 9.-3A.44	3RF2900-0EA18	--	3RF2990-0GA16	3RF2932-0JA16	--

3RF29 Function Modules

General data

Assignment of the function modules to the 3RF23 contactors

Order No.	Accessories				
	Converters	Load monitoring		Heating current monitoring	Power controllers
		Basic	Extended		
Type current $I_e = 10.5 \text{ A}$					
3RF23 1.-1A.02	3RF2900-0EA18	3RF2920-0FA08	3RF2920-0GA13	3RF2916-0JA13	--
3RF23 1.-1A.04	3RF2900-0EA18	3RF2920-0FA08	3RF2920-0GA16	3RF2932-0JA16	--
3RF23 1.-1A.06	3RF2900-0EA18	3RF2920-0FA08	3RF2920-0GA16	3RF2932-0JA16	--
3RF23 1.-1A.12	3RF2900-0EA18	--	3RF2920-0GA13	3RF2916-0JA13	--
3RF23 1.-1A.22	--	--	3RF2920-0GA33	--	--
3RF23 1.-1A.24	--	--	3RF2920-0GA36	--	--
3RF23 1.-1A.26	--	--	3RF2920-0GA36	--	--
3RF23 1.-1A.44	3RF2900-0EA18	3RF2920-0FA08	3RF2920-0GA16	3RF2932-0JA16	--
3RF23 1.-1B.02	3RF2900-0EA18	3RF2920-0FA08	3RF2920-0GA13	3RF2916-0JA13	3RF2920-0HA13
3RF23 1.-1B.04	3RF2900-0EA18	3RF2920-0FA08	3RF2920-0GA16	3RF2932-0JA16	3RF2920-0HA16
3RF23 1.-1B.06	3RF2900-0EA18	3RF2920-0FA08	3RF2920-0GA16	3RF2932-0JA16	3RF2920-0HA16
3RF23 1.-1B.22	--	--	3RF2920-0GA33	--	3RF2920-0HA33
3RF23 1.-1B.24	--	--	3RF2920-0GA36	--	3RF2920-0HA36
3RF23 1.-1B.26	--	--	3RF2920-0GA36	--	3RF2920-0HA36
3RF23 1.-2A.02	3RF2900-0EA18	--	--	--	--
3RF23 1.-2A.04	3RF2900-0EA18	--	--	--	--
3RF23 1.-2A.06	3RF2900-0EA18	--	--	--	--
3RF23 1.-2A.22	--	--	--	--	--
3RF23 1.-2A.24	--	--	--	--	--
3RF23 1.-2A.26	--	--	--	--	--
3RF23 1.-3A.02	3RF2900-0EA18	--	3RF2920-0GA13	3RF2916-0JA13	--
3RF23 1.-3A.04	3RF2900-0EA18	--	3RF2920-0GA16	3RF2932-0JA16	--
3RF23 1.-3A.06	3RF2900-0EA18	--	3RF2920-0GA16	3RF2932-0JA16	--
3RF23 1.-3A.22	--	--	3RF2920-0GA33	--	--
3RF23 1.-3A.24	--	--	3RF2920-0GA36	--	--
3RF23 1.-3A.26	--	--	3RF2920-0GA36	--	--
Type current $I_e = 20 \text{ A}$					
3RF23 2.-1A.02	3RF2900-0EA18	3RF2920-0FA08	3RF2920-0GA13	--	--
3RF23 2.-1A.04	3RF2900-0EA18	3RF2920-0FA08	3RF2920-0GA16	3RF2932-0JA16	--
3RF23 2.-1A.06	3RF2900-0EA18	3RF2920-0FA08	3RF2920-0GA16	3RF2932-0JA16	--
3RF23 2.-1A.14	3RF2900-0EA18	--	3RF2920-0GA16	--	--
3RF23 2.-1A.22	--	--	3RF2920-0GA33	--	--
3RF23 2.-1A.24	--	--	3RF2920-0GA36	--	--
3RF23 2.-1A.26	--	--	3RF2920-0GA36	--	--
3RF23 2.-1A.44	3RF2900-0EA18	3RF2920-0FA08	3RF2920-0GA16	3RF2932-0JA16	--
3RF23 2.-1A.45	3RF2900-0EA18	3RF2920-0FA08	3RF2920-0GA16	3RF2932-0JA16	--
3RF23 2.-1B.02	3RF2900-0EA18	3RF2920-0FA08	3RF2920-0GA13	--	3RF2920-0HA13
3RF23 2.-1B.04	3RF2900-0EA18	3RF2920-0FA08	3RF2920-0GA16	3RF2932-0JA16	3RF2920-0HA16
3RF23 2.-1B.06	3RF2900-0EA18	3RF2920-0FA08	3RF2920-0GA16	3RF2932-0JA16	3RF2920-0HA16
3RF23 2.-1B.22	--	--	3RF2920-0GA33	--	3RF2920-0HA33
3RF23 2.-1B.24	--	--	3RF2920-0GA36	--	3RF2920-0HA36
3RF23 2.-1B.26	--	--	3RF2920-0GA36	--	3RF2920-0HA36
3RF23 2.-1C.02	3RF2900-0EA18	3RF2920-0FA08	3RF2920-0GA13	--	--
3RF23 2.-1C.04	3RF2900-0EA18	3RF2920-0FA08	3RF2920-0GA16	3RF2932-0JA16	--
3RF23 2.-1C.22	--	--	3RF2920-0GA33	--	--
3RF23 2.-1C.24	--	--	3RF2920-0GA36	--	--
3RF23 2.-1C.44	3RF2900-0EA18	3RF2920-0FA08	3RF2920-0GA16	3RF2932-0JA16	--
3RF23 2.-1D.02	3RF2900-0EA18	3RF2920-0FA08	3RF2920-0GA13	--	--
3RF23 2.-1D.04	3RF2900-0EA18	3RF2920-0FA08	3RF2920-0GA16	3RF2932-0JA16	--
3RF23 2.-1D.22	--	--	3RF2920-0GA33	--	--
3RF23 2.-1D.24	--	--	3RF2920-0GA36	--	--
3RF23 2.-1D.44	3RF2900-0EA18	3RF2920-0FA08	3RF2920-0GA16	3RF2932-0JA16	--

3RF29 Function Modules

General data

Order No.	Accessories Converters	Load monitoring		Heating current monitoring	Power controllers
		Basic	Extended		
Type current $I_e = 20\text{ A}$					
3RF23 2.-2A.02	3RF2900-0EA18	--	--	--	--
3RF23 2.-2A.04	3RF2900-0EA18	--	--	--	--
3RF23 2.-2A.06	3RF2900-0EA18	--	--	--	--
3RF23 2.-2A.22	--	--	--	--	--
3RF23 2.-2A.24	--	--	--	--	--
3RF23 2.-2A.26	--	--	--	--	--
3RF23 2.-2C.02	3RF2900-0EA18	--	--	--	--
3RF23 2.-2C.04	3RF2900-0EA18	--	--	--	--
3RF23 2.-2C.22	--	--	--	--	--
3RF23 2.-2C.24	--	--	--	--	--
3RF23 2.-2D.22	--	--	--	--	--
3RF23 2.-2D.24	--	--	--	--	--
3RF23 2.-3A.02	3RF2900-0EA18	--	3RF2920-0GA13	--	--
3RF23 2.-3A.04	3RF2900-0EA18	--	3RF2920-0GA16	3RF2932-0JA16	--
3RF23 2.-3A.06	3RF2900-0EA18	--	3RF2920-0GA16	3RF2932-0JA16	--
3RF23 2.-3A.22	--	--	3RF2920-0GA33	--	--
3RF23 2.-3A.24	--	--	3RF2920-0GA36	--	--
3RF23 2.-3A.26	--	--	3RF2920-0GA36	--	--
3RF23 2.-3A.44	3RF2900-0EA18	--	3RF2920-0GA16	3RF2932-0JA16	--
3RF23 2.-3D.02	3RF2900-0EA18	--	3RF2920-0GA13	--	--
3RF23 2.-3D.04	3RF2900-0EA18	--	3RF2920-0GA16	3RF2932-0JA16	--
3RF23 2.-3D.22	--	--	3RF2920-0GA33	--	--
3RF23 2.-3D.24	--	--	3RF2920-0GA36	--	--
Type current $I_e = 30\text{ A}$					
3RF23 3.-1A.02	3RF2900-0EA18	3RF2920-0FA08	3RF2950-0GA13	--	--
3RF23 3.-1A.04	3RF2900-0EA18	3RF2920-0FA08	3RF2950-0GA16	3RF2932-0JA16	--
3RF23 3.-1A.06	3RF2900-0EA18	3RF2920-0FA08	3RF2950-0GA16	3RF2932-0JA16	--
3RF23 3.-1A.14	3RF2900-0EA18	--	3RF2950-0GA16	3RF2932-0JA16	--
3RF23 3.-1A.22	--	--	3RF2950-0GA33	--	--
3RF23 3.-1A.24	--	--	3RF2950-0GA36	--	--
3RF23 3.-1A.26	--	--	3RF2950-0GA36	--	--
3RF23 3.-1A.44	3RF2900-0EA18	--	3RF2950-0GA16	3RF2932-0JA16	--
3RF23 3.-1B.02	3RF2900-0EA18	3RF2920-0FA08	3RF2950-0GA13	--	3RF2950-OHA13
3RF23 3.-1B.04	3RF2900-0EA18	3RF2920-0FA08	3RF2950-0GA16	3RF2932-0JA16	3RF2950-OHA16
3RF23 3.-1B.06	3RF2900-0EA18	3RF2920-0FA08	3RF2950-0GA16	3RF2932-0JA16	3RF2950-OHA16
3RF23 3.-1B.22	--	--	3RF2950-0GA33	--	3RF2950-OHA33
3RF23 3.-1B.24	--	--	3RF2950-0GA36	--	3RF2950-OHA36
3RF23 3.-1B.26	--	--	3RF2950-0GA36	--	3RF2950-OHA36
3RF23 3.-1B.44	3RF2900-0EA18	--	3RF2950-0GA16	3RF2932-0JA16	--
3RF23 3.-1C.02	3RF2900-0EA18	3RF2920-0FA08	3RF2950-0GA13	--	--
3RF23 3.-1D.44	3RF2900-0EA18	--	3RF2950-0GA16	3RF2932-0JA16	--
3RF23 3.-3A.02	3RF2900-0EA18	--	3RF2950-0GA13	--	--
3RF23 3.-3A.04	3RF2900-0EA18	--	3RF2950-0GA16	3RF2932-0JA16	--
3RF23 3.-3A.06	3RF2900-0EA18	--	3RF2950-0GA16	3RF2932-0JA16	--
3RF23 3.-3A.22	--	--	3RF2950-0GA33	--	--
3RF23 3.-3A.24	--	--	3RF2950-0GA36	--	--
3RF23 3.-3A.26	--	--	3RF2950-0GA36	--	--
3RF23 3.-3A.44	3RF2900-0EA18	--	3RF2950-0GA16	3RF2932-0JA16	--
Type current $I_e = 40\text{ A}$					
3RF23 4.-1A.02	3RF2900-0EA18	--	3RF2950-0GA13	--	--
3RF23 4.-1A.04	3RF2900-0EA18	--	3RF2950-0GA16	--	--
3RF23 4.-1A.06	3RF2900-0EA18	--	3RF2950-0GA16	--	--
3RF23 4.-1A.22	--	--	3RF2950-0GA33	--	--
3RF23 4.-1A.24	--	--	3RF2950-0GA36	--	--
3RF23 4.-1A.26	--	--	3RF2950-0GA36	--	--
3RF23 4.-1A.45	3RF2900-0EA18	--	3RF2950-0GA16	--	--
3RF23 4.-1B.02	3RF2900-0EA18	--	3RF2950-0GA13	--	3RF2950-OHA13
3RF23 4.-1B.04	3RF2900-0EA18	--	3RF2950-0GA13	--	3RF2950-OHA16
3RF23 4.-1B.06	3RF2900-0EA18	--	3RF2950-0GA13	--	3RF2950-OHA16
3RF23 4.-1B.22	--	--	3RF2950-0GA33	--	3RF2950-OHA33
3RF23 4.-1B.24	--	--	3RF2950-0GA36	--	3RF2950-OHA36
3RF23 4.-1B.26	--	--	3RF2950-0GA36	--	3RF2950-OHA36
3RF23 4.-3A.02	3RF2900-0EA18	--	3RF2950-0GA13	--	--
3RF23 4.-3A.04	3RF2900-0EA18	--	3RF2950-0GA16	--	--
3RF23 4.-3A.06	3RF2900-0EA18	--	3RF2950-0GA16	--	--
3RF23 4.-3A.22	--	--	3RF2950-0GA33	--	--
3RF23 4.-3A.24	--	--	3RF2950-0GA36	--	--
3RF23 4.-3A.26	--	--	3RF2950-0GA36	--	--
3RF23 4.-3A.45	3RF2900-0EA18	--	3RF2950-0GA16	--	--

3RF29 Function Modules

General data

Order No.	Accessories				
	Converters	Load monitoring		Heating current monitoring	Power controllers
		Basic	Extended		
Type current $I_e = 50$ A					
3RF23 5.-1A.02	3RF2900-0EA18	--	3RF2950-0GA13	--	--
3RF23 5.-1A.04	3RF2900-0EA18	--	3RF2950-0GA16	--	--
3RF23 5.-1A.06	3RF2900-0EA18	--	3RF2950-0GA16	--	--
3RF23 5.-1A.22	--	--	3RF2950-0GA33	--	--
3RF23 5.-1A.24	--	--	3RF2950-0GA36	--	--
3RF23 5.-1A.26	--	--	3RF2950-0GA36	--	--
3RF23 5.-1A.45	3RF2900-0EA18	--	3RF2950-0GA16	--	--
3RF23 5.-1B.02	3RF2900-0EA18	--	3RF2950-0GA13	--	3RF2950-0HA13
3RF23 5.-1B.04	3RF2900-0EA18	--	3RF2950-0GA16	--	3RF2950-0HA16
3RF23 5.-1B.06	3RF2900-0EA18	--	3RF2950-0GA16	--	3RF2950-0HA16
3RF23 5.-1B.22	--	--	3RF2950-0GA33	--	3RF2950-0HA33
3RF23 5.-1B.24	--	--	3RF2950-0GA36	--	3RF2950-0HA36
3RF23 5.-1B.26	--	--	3RF2950-0GA36	--	3RF2950-0HA36
3RF23 5.-1B.44	3RF2900-0EA18	--	3RF2950-0GA16	--	3RF2950-0HA16
3RF23 5.-3A.02	3RF2900-0EA18	--	3RF2950-0GA13	--	--
3RF23 5.-3A.04	3RF2900-0EA18	--	3RF2950-0GA16	--	--
3RF23 5.-3A.06	3RF2900-0EA18	--	3RF2950-0GA16	--	--
3RF23 5.-3A.22	--	--	3RF2950-0GA33	--	--
3RF23 5.-3A.24	--	--	3RF2950-0GA36	--	--
3RF23 5.-3A.26	--	--	3RF2950-0GA36	--	--
3RF23 5.-3A.44	3RF2900-0EA18	--	3RF2950-0GA16	--	--
Type current $I_e = 70$ A					
3RF23 7.-1B.02	3RF2900-0EA18	--	3RF2990-0GA13	--	3RF2990-0HA13
3RF23 7.-1B.04	3RF2900-0EA18	--	3RF2990-0GA16	--	3RF2990-0HA16
3RF23 7.-1B.06	3RF2900-0EA18	--	3RF2990-0GA16	--	3RF2990-0HA16
3RF23 7.-1B.22	--	--	3RF2990-0GA33	--	3RF2990-0HA33
3RF23 7.-1B.24	--	--	3RF2990-0GA36	--	3RF2990-0HA36
3RF23 7.-1B.26	--	--	3RF2990-0GA36	--	3RF2990-0HA36
3RF23 7.-3A.02	3RF2900-0EA18	--	3RF2990-0GA13	--	--
3RF23 7.-3A.04	3RF2900-0EA18	--	3RF2990-0GA16	--	--
3RF23 7.-3A.06	3RF2900-0EA18	--	3RF2990-0GA16	--	--
3RF23 7.-3A.22	--	--	3RF2990-0GA33	--	--
3RF23 7.-3A.24	--	--	3RF2990-0GA36	--	--
3RF23 7.-3A.26	--	--	3RF2990-0GA36	--	--
3RF23 7.-3A.45	3RF2900-0EA18	--	3RF2990-0GA16	--	--
3RF23 7.-3B.02	3RF2900-0EA18	--	3RF2990-0GA13	--	3RF2990-0HA13
3RF23 7.-3B.04	3RF2900-0EA18	--	3RF2990-0GA16	--	3RF2990-0HA16
3RF23 7.-3B.06	3RF2900-0EA18	--	3RF2990-0GA16	--	3RF2990-0HA16
3RF23 7.-3B.22	--	--	3RF2990-0GA33	--	3RF2990-0HA33
3RF23 7.-3B.24	--	--	3RF2990-0GA36	--	3RF2990-0HA36
3RF23 7.-3B.26	--	--	3RF2990-0GA36	--	3RF2990-0HA36
Type current $I_e = 90$ A					
3RF23 9.-1B.02	3RF2900-0EA18	--	3RF2990-0GA13	--	3RF2990-0HA13
3RF23 9.-1B.04	3RF2900-0EA18	--	3RF2990-0GA16	--	3RF2990-0HA16
3RF23 9.-1B.06	3RF2900-0EA18	--	3RF2990-0GA16	--	3RF2990-0HA16
3RF23 9.-1B.22	--	--	3RF2990-0GA33	--	3RF2990-0HA33
3RF23 9.-1B.24	--	--	3RF2990-0GA36	--	3RF2990-0HA36
3RF23 9.-1B.26	--	--	3RF2990-0GA36	--	3RF2990-0HA36
3RF23 9.-3A.02	3RF2900-0EA18	--	3RF2990-0GA13	--	--
3RF23 9.-3A.04	3RF2900-0EA18	--	3RF2990-0GA16	--	--
3RF23 9.-3A.06	3RF2900-0EA18	--	3RF2990-0GA16	--	--
3RF23 9.-3A.22	--	--	3RF2990-0GA33	--	--
3RF23 9.-3A.24	--	--	3RF2990-0GA36	--	--
3RF23 9.-3A.26	--	--	3RF2990-0GA36	--	--
3RF23 9.-3A.45	3RF2900-0EA18	--	3RF2990-0GA16	--	--
3RF23 9.-3B.02	3RF2900-0EA18	--	3RF2990-0GA13	--	3RF2990-0HA13
3RF23 9.-3B.04	3RF2900-0EA18	--	3RF2990-0GA16	--	3RF2990-0HA16
3RF23 9.-3B.06	3RF2900-0EA18	--	3RF2990-0GA16	--	3RF2990-0HA16
3RF23 9.-3B.22	--	--	3RF2990-0GA33	--	3RF2990-0HA33
3RF23 9.-3B.24	--	--	3RF2990-0GA36	--	3RF2990-0HA36
3RF23 9.-3B.26	--	--	3RF2990-0GA36	--	3RF2990-0HA36

3RF29 Function Modules

Converters

Overview

Converters for SIRIUS SC solid-state switching devices

These modules are used to convert analog drive signals, such as those output from many temperature controllers for example, into a pulse-width-modulated digital signal. The connected solid-state contactors and relays can therefore regulate the output of a load as a percentage.

Application

The device is used for conversion from an analog input signal to an on/off ratio. The function module can only be used in conjunction with a 3RF21 solid-state relay or a 3RF23 solid-state contactor.

Selection and ordering data

Rated operating current I_e	Rated operating voltage U_e	DT	Order No.	Price per PU	PU (UNIT, SET, M)	PS*	PG	Weight per PU approx. kg
----------------------------------	----------------------------------	----	-----------	--------------	-------------------	-----	----	-----------------------------

Converters



	Rated control supply voltage 24 V AC/DC		A	3RF29 00-0EA18	1	1 unit	101	0.041
--	---	--	---	-----------------------	---	--------	-----	-------

3RF29 Function Modules

Load monitoring and heating current monitoring

Overview

Load monitoring for SIRIUS SC solid-state switching devices



Many faults can be quickly detected by monitoring a load circuit connected to the solid-state switching device, as made possible with this module. Examples include the failure of load elements (up to 6 in the basic version or up to 12 in the extended version), alloyed power semiconductors, a lack of voltage or a break in a load circuit. A fault is indicated by one or more LEDs and reported to the controller by way of a PLC-compatible output.

The operating principle is based on permanent monitoring of the current intensity. This figure is continuously compared with the reference value stored once during commissioning by the simple press of a button. In order to detect the failure of one of several loads, the current difference must be 1/6 (in the basic version and heating current monitoring) or 1/12 (in the extended version) of the reference value. In the event of a fault, an output is actuated and one or more LEDs indicate the fault.

Application

The device is used for monitoring one or more loads (partial loads). The function module can only be used in conjunction with a 3RF21 solid-state relay or a 3RF23 solid-state contactor. The devices with spring-loaded connections in the load circuit are not suitable.

Selection and ordering data

	Rated operating current I_e	Rated operating voltage U_e	DT	Order No.	Price per PU	PU (UNIT, SET, M)	PS*	PG	Weight per PU approx. kg	
Basic load monitoring										
	Rated control supply voltage 24 V DC									
	20	--	A	3RF29 20-0FA08		1	1 unit	101	0.068	
Extended load monitoring										
	Rated control supply voltage 24 V AC/DC									
	20	110 ... 230	A	3RF29 20-0GA13		1	1 unit	101	0.175	
	20	400 ... 600	A	3RF29 20-0GA16		1	1 unit	101	0.175	
	50	110 ... 230	A	3RF29 50-0GA13		1	1 unit	101	0.175	
	50	400 ... 600	A	3RF29 50-0GA16		1	1 unit	101	0.175	
	90	110 ... 230	A	3RF29 90-0GA13		1	1 unit	101	0.175	
	90	400 ... 600	A	3RF29 90-0GA16		1	1 unit	101	0.175	
	Rated control supply voltage 110 V AC									
	20	110 ... 230	A	3RF29 20-0GA33		1	1 unit	101	0.175	
	20	400 ... 600	A	3RF29 20-0GA36		1	1 unit	101	0.175	
	50	110 ... 230	A	3RF29 50-0GA33		1	1 unit	101	0.175	
	50	400 ... 600	A	3RF29 50-0GA36		1	1 unit	101	0.175	
90	110 ... 230	A	3RF29 90-0GA33		1	1 unit	101	0.175		
90	400 ... 600	A	3RF29 90-0GA36		1	1 unit	101	0.175		
Heating current monitoring										
	Rated control supply voltage 24 V AC/DC									
	16	110 ... 230	A	3RF29 16-0JA13		1	1 unit	101	0.175	
	32	400 ... 600	A	3RF29 32-0JA16		1	1 unit	101	0.175	

* You can order this quantity or a multiple thereof.

3RF29 Function Modules

Power controllers

Overview

Power controllers for SIRIUS SC solid-state switching devices

The following functions have been integrated:

- **Power control regulator with proportional-action control** for adjusting the power of the connected load. Here, the setpoint is set with a rotary knob on the module as a percentage with reference to the 100 % power stored as a setpoint. In this way the power is kept constant even in the event of voltage fluctuations or a change in load resistance.
- **Inrush current limitation:** With the aid of an adjustable voltage ramp, the inrush current is limited by means of phase control. This is useful above all with loads such as lamps which have an inrush transient current.
- **Load circuit monitoring** for detecting load failure, alloyed power semiconductors, lack of voltage or a break in the load circuit.

Application

The power controller adjusts the current in the connected load by means of a solid-state switching device depending on a setpoint. Changes in the mains voltage or in the load resistance are thus compensated by the power controller. The setpoint can be predefined externally as a 0 to 10 V signal or internally by means of a potentiometer. Depending on the setting of the potentiometer (t_p), the adjustment is carried out according to the principle of full-wave control or generalized phase control.

Full-wave control

In this operating mode the output is adjusted to the required setpoint by changing the on-to-off period. The period duration is predefined at one second.

Generalized phase control

In this operating mode the output is adjusted to the required setpoint by changing the current flow angle. In order to observe the limit values of the conducted interference voltage for industrial networks, a choke rated at at least 200 μH must be included in the load circuit.

Selection and ordering data

Rated operating current I_e	Rated operating voltage U_e	DT	Order No.	Price per PU	PU (UNIT, SET, M)	PS*	PG	Weight per PU approx. kg
A	V							

Power controllers



Rated control supply voltage 24 V AC/DC								
20	110 ... 230	A	3RF29 20-0HA13		1	1 unit	101	0.175
20	400 ... 600	A	3RF29 20-0HA16		1	1 unit	101	0.175
50	110 ... 230	A	3RF29 50-0HA13		1	1 unit	101	0.175
50	400 ... 600	A	3RF29 50-0HA16		1	1 unit	101	0.175
90	110 ... 230	A	3RF29 90-0HA13		1	1 unit	101	0.175
90	400 ... 600	A	3RF29 90-0HA16		1	1 unit	101	0.175
Rated control supply voltage 110 V AC								
20	110 ... 230	A	3RF29 20-0HA33		1	1 unit	101	0.175
20	400 ... 600	A	3RF29 20-0HA36		1	1 unit	101	0.175
50	110 ... 230	A	3RF29 50-0HA33		1	1 unit	101	0.175
50	400 ... 600	A	3RF29 50-0HA36		1	1 unit	101	0.175
90	110 ... 230	A	3RF29 90-0HA33		1	1 unit	101	0.175
90	400 ... 600	A	3RF29 90-0HA36		1	1 unit	101	0.175