

SIEMENS

MICROMASTER 420

Parameter List

Version 12/01



User Documentation
6SE6400-5BA00-0BP0

Getting Started Guide

Is for quick commissioning with SDP and BOP.



Operating Instructions

Gives information about features of the MM420, Installation, Commissioning, Control modes, System Parameter structure, Troubleshooting, Specifications and available options of the MM420.



Parameter List

The Parameterlist contains the description of all Parameters structured in functional order and a detailed description. The Parameter list also includes a series of function plans.



Reference Manual

The reference Manual gives elaborate information about engineering communication troubleshooting and maintenance.



Catalogues

In the catalogue you will find all needs to select a certain inverter, as well as filters chokes, operator panels or communications options.



SIEMENS

MICROMASTER 420

Parameter List
User Documentation

Valid for

Version 12/01

Converter Type
MICROMASTER 420

Software Version
V1.1

Version 12/01

Parameter List	1
Alarms and Warnings	2



Warning

Please refer to all Definitions and Warnings contained in the Operating Instructions. You will find the Operating Instructions on the Docu CD delivered with your inverter. If the CD is lost, it can be ordered via your local Siemens department under the Order No. 6SE6400-5FA00-1AG00.

Further information can be obtained from Internet website:
<http://www.siemens.de/micromaster>

Approved Siemens Quality for Software and Training
is to DIN ISO 9001, Reg. No. 2160-01

The reproduction, transmission or use of this document, or its contents is not permitted unless authorized in writing. Offenders will be liable for damages. All rights including rights created by patent grant or registration of a utility model or design are reserved.

© Siemens AG 2001. All Rights Reserved.

MICROMASTER® is a registered trademark of Siemens

Other functions not described in this document may be available. However, this fact shall not constitute an obligation to supply such functions with a new control, or when servicing.

We have checked that the contents of this document correspond to the hardware and software described. There may be discrepancies nevertheless, and no guarantee can be given that they are completely identical. The information contained in this document is reviewed regularly and any necessary changes will be included in the next edition. We welcome suggestions for improvement.

Siemens handbooks are printed on chlorine-free paper that has been produced from managed sustainable forests. No solvents have been used in the printing or binding process.

Document subject to change without prior notice.

Order number: 6SE6400-5BA00-0BP0
Printed in the Federal of Germany

Siemens-Aktiengesellschaft.

Parameters MICROMASTER 420

This Parameter List must only be used together with the Operating Instructions or the Reference Manual of the MICROMASTER 420. Please pay special attention to the Warnings, Cautions, Notices and Notes contained in these manuals.

Table of Contents

1	Parameters.....	7
1.1	Introduction to MICROMASTER 420 System Parameters	7
1.2	Quick commissioning (P0010=1)	9
1.3	Parameter Description.....	11
2	Alarms and Warnings.....	93
2.1	MICROMASTER 420 fault messages.....	93
2.2	MICROMASTER 420 alarm messages.....	95

1 Parameters

1.1 Introduction to MICROMASTER 420 System Parameters

The layout of the parameter description is as follows.

1 Par number [index]	2 Parameter name	5 Datatype	7 Unit:	9 Min:	12 Level:
	3 CStat:	6 active:	8 Quick Comm:	10 Def:	2
	4 P-Group:			11 Max:	

13 Description:

1. Parameter number

Indicates the relevant parameter number. The numbers used are 4-digit numbers in the range 0000 to 9999. Numbers prefixed with an "r" indicate that the parameter is a "read-only" parameter, which displays a particular value but cannot be changed directly by specifying a different value via this parameter number (in such cases, dashes "-" are entered at the points "Unit", "Min", "Def" and "Max" in the header of the parameter description.

All other parameters are prefixed with a "P". The values of these parameters can be changed directly in the range indicated by the "Min" and "Max" settings in the header.

[index] indicates that the parameter is an indexed parameter and specifies the number of indices available.

2. Parameter name

Indicates the name of the relevant parameter. Certain parameter names include the following abbreviated prefixes: BI, BO, CI, and CO followed by a colon.

These abbreviations have the following meanings:

BI	=	Binector input, i.e. parameter selects the source of a binary signal
BO	=	Binector output, i.e. parameter connects as a binary signal
CI	=	Connector input, i.e. parameter selects the source of an analog signal
CO	=	Connector output, i.e. parameter connects as an analog signal
CO/BO	=	Connector/Binector output, i.e. parameter connects as an analog signal and/or as a binary signal

To make use of BiCo you will need access to the full parameter list. At this level many new parameter settings are possible, including BiCo functionality. BiCo functionality is a different, more flexible way of setting and combining input and output functions. It can be used in most cases in conjunction with the simple, level 2 settings.

The BiCo system allows complex functions to be programmed. Boolean and mathematical relationships can be set up between inputs (digital, analog, serial etc.) and outputs (inverter current, frequency, analog output, relays, etc.).

3. CStat

Commissioning status of the parameter. Three states are possible:

Commissioning	C
Run	U
Ready to Run	T

This indicates when the parameter can be changed. One, two or all three states may be specified. If all three states are specified, this means that it is possible to change this parameter setting in all three inverter states

4. **P-Group**

Indicates the functional group of the particular.

Note

Parameter P0004 (parameter filter) acts as a filter and focuses access to parameters according to the functional group selected.

5. **Datatype**

The data types available are shown in the table below.

Notation	Meaning
U16	16-bit unsigned
U32	32-bit unsigned
I16	16-bit integer
I32	32-bit integer
Float	Floating point

6. **Active**

Indicates whether

- ◆ Immediately changes to the parameter values take effective immediately after they have been entered, or
- ◆ Confirm the “P” button on the operator panel (BOP or AOP) must be pressed before the changes take effect.

7. **Unit**

Indicates the unit of measure applicable to the parameter values

8. **QuickComm**

Indicates whether or not (Yes or No) a parameter can only be changed during quick commissioning, i.e. when P0010 (parameter groups for commissioning) is set to 1 (quick commissioning).

9. **Min**

Indicates the minimum value to which the parameter can be set.

10. **Def**

Indicates the default value, i.e. the value which applies if the user does not specify a particular value for the parameter.

11. **Max**

Indicates the maximum value to which the parameter can be set.

12. **Level**

Indicates the level of user access. There are four access levels: Standard, Extended, Expert and Service. The number of parameters that appear in each functional group depends on the access level set in P0003 (user access level).

13. **Description**

The parameter description consists of the sections and contents listed below. Some of these sections and contents are optional and will be omitted on a case-to-case basis if not applicable.

Description:	Brief explanation of the parameter function.
Diagram:	Where applicable, diagram to illustrate the effects of parameters on a characteristic curve, for example
Settings:	List of applicable settings. These include Possible settings, Most common settings, Index and Bitfields
Example:	Optional example of the effects of a particular parameter setting.
Dependency:	Any conditions that must be satisfied in connection with this parameter. Also any particular effects, which this parameter has on other parameter(s) or which other parameters have on this one.
Warning / Caution / Notice / Note:	Important information which must be heeded to prevent personal injury or damage to equipment / specific information which should be heeded in order to avoid problems / information which may be helpful to the user
More details:	Any sources of more detailed information concerning the particular parameter.

1.2 Quick commissioning (P0010=1)

The following parameters are necessary for quick commissioning (P0010=1).

No	Name	Access level	Cstat
P0100	Europe / North America	1	C
P0300	Select motor type	2	C
P0304	Motor voltage rating	1	C
P0305	Motor current rating	1	C
P0307	Motor power rating	1	C
P0308	Motor cosPhi rating	2	C
P0309	Motor efficiency rating	2	C
P0310	Motor frequency rating	1	C
P0311	Motor speed rating	1	C
P0320	Motor magnetizing current	3	CT
P0335	Motor cooling	2	CT
P0640	Motor overload factor [%]	2	CUT
P0700	Selection of command source	1	CT
P1000	Selection of frequency setpoint	1	CT
P1080	Min. speed	1	CUT
P1082	Max. speed	1	CT
P1120	Ramp-up time	1	CUT
P1121	Ramp-down time	1	CUT
P1135	OFF3 ramp-down time	2	CUT
P1300	Control mode	2	CT
P1910	Select motor data identification	2	CT
P3900	End of quick commissioning	1	C

When P0010=1 is chosen, P0003 (user access level) can be used to select the parameters to be accessed. This parameter also allows selection of a user-defined parameter list for quick commissioning.

At the end of the quick commissioning sequence, set P3900 = 1 to carry out the necessary motor calculations and clear all other parameters (not included in P0010=1) to their default settings.

Note

This applies only in Quick Commissioning mode.

Reset to Factory default

To reset all parameters to the factory default settings; the following parameters should be set as follows:

Set P0010=30.

Set P0970=1.

Note

The reset process takes approximately 10 seconds to complete. Reset to Factory default

Seven-segment display

The seven-segment display is structured as follows:

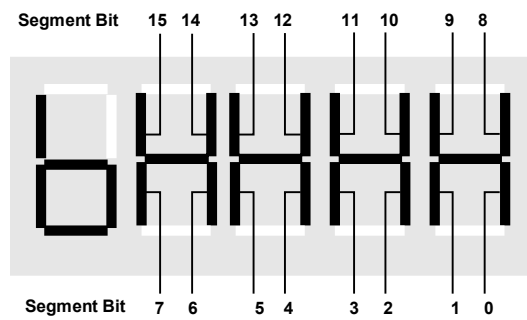

The significance of the relevant bits in the display is described in the status and control word parameters.

1.3 Parameter Description

Note:

Level 4 Parameters are not visible with BOP or AOP.

r0000	Drive display	Datatype: U16	Unit: -	Min: - Def: - Max: -	Level: 1
	P-Group: ALWAYS				

Displays the user selected output as defined in P0005.

Note:

Pressing the "Fn" button for 2 seconds allows the user to view the values of DC link voltage, output current, output frequency, and chosen r0000 setting (defined in P0005).

r0002	Drive state	Datatype: U16	Unit: -	Min: - Def: - Max: -	Level: 2
	P-Group: COMMANDS				

Displays actual drive state.

Enum:

- 0 Commissioning mode (P0010 != 0)
- 1 Drive ready
- 2 Drive fault active
- 3 Drive starting (DC-link precharging)
- 4 Drive running
- 5 Stopping (ramping down)

Dependency:

State 3 visible only while precharging DC link, and when externally powered communications board is fitted.

P0003	User access level	Datatype: U16	Unit: -	Min: 0 Def: 1 Max: 4	Level: 1
	CStat: CUT	Active: Immediately	QuickComm. No		
	P-Group: ALWAYS				

Defines user access level to parameter sets. The default setting (standard) is sufficient for most simple applications.

Enum:

- 0 User defined parameter list - see P0013 for details on use
- 1 Standard: Allows access into most frequently used parameters.
- 2 Extended: Allows extended access e.g. to inverter I/O functions.
- 3 Expert: For expert use only.
- 4 Service: Only for use by authorized service personal - password protected.

P0004	Parameter filter	Datatype: U16	Unit: -	Min: 0 Def: 0 Max: 22	Level: 1
	CStat: CUT	Active: Immediately	QuickComm. No		
	P-Group: ALWAYS				

Filters available parameters according to functionality to enable a more focussed approach to commissioning.

Example:

P0004 = 22 specifies that only PID parameters will be visible.

Enum:

- 0 All parameters
- 2 Inverter
- 3 Motor
- 7 Commands, binary I/O
- 8 ADC and DAC
- 10 Setpoint channel / RFG
- 12 Drive features
- 13 Motor control
- 20 Communication
- 21 Alarms / warnings / monitoring
- 22 Technology controller (e.g. PID)

Dependency:

Parameters marked "Quick Comm: Yes" in the parameter header can only be set when P0010 = 1 (Quick Commissioning).

Note:

The inverter will start with any setting of P0004.

P0005	Display selection	Datatype: U16	Unit: -	Min: 2	Level: 2
	CStat: CUT	Active: Immediately	QuickComm. No	Def: 21	
	P-Group: FUNC			Max: 2294	

Selects display for parameter r0000 (drive display). Any read-only parameter (rxxxx) can be selected

Common Settings:
 21 Actual frequency
 25 Output voltage
 26 DC link voltage
 27 Output current

Notice:
 These settings refer to read only parameter numbers ("rxxxx").

Details:
 See relevant "rxxxx" parameter descriptions for further functions.

P0006	Display mode	Datatype: U16	Unit: -	Min: 0	Level: 3
	CStat: CUT	Active: Immediately	QuickComm. No	Def: 2	
	P-Group: FUNC			Max: 4	

Defines mode of display for r0000 (drive display).

Enum:
 0 In Ready state alternate between setpoint and output freq. In run display output freq.
 1 In Ready state display setpoint. In run display output freq.
 2 In Ready state alternate between P0005 value and r0020 value. In run display P0005 value
 3 In Ready state alternate between r0002 value and r0020 value. In run display r0002 value
 4 In all states just display P0005

Note:
 When inverter is not running, the display alternates between the values for "Not Running" and "Running".

Per default, the setpoint and actual frequency values are displayed alternately.

P0007	Backlight delay time	Datatype: U16	Unit: -	Min: 0	Level: 3
	CStat: CUT	Active: Immediately	QuickComm. No	Def: 0	
	P-Group: FUNC			Max: 2000	

Defines time period after which the backlight display turns off if no operator keys have been pressed.

Value:
 P0007 = 0 : Backlight always on (default state)

P0007 = 1-2000 : Number of seconds after which the backlight will turn off

P0010	Commissioning parameter filter	Datatype: U16	Unit: -	Min: 0	Level: 1
	CStat: CT	Active: Immediately	QuickComm. No	Def: 0	
	P-Group: ALWAYS			Max: 30	

Filters parameters so that only those related to a particular functional group are selected.

Enum:
 0 Ready
 1 Quick commissioning
 2 Inverter
 29 Download
 30 Factory setting

Dependency:
 Reset to 0 for inverter to run.

P0003 (user access level) also determines access to parameters.

Note:
 If P3900 is not 0 (0 is the default value), this parameter is automatically reset to 0.
 Settings 2 and 29 are only visible in service mode.

P0011	Lock for user defined parameter	Datatype: U16	Unit: -	Min: 0	Level: 3
	CStat: CUT	Active: Immediately	QuickComm. No	Def: 0	
	P-Group: FUNC			Max: 65535	

Details:
 See parameter P0013 (user defined parameter)

P0012	Key for user defined parameter	Datatype: U16	Unit: -	Min: 0	Level: 3
	CStat: CUT	Active: Immediately	QuickComm. No	Def: 0	
	P-Group: FUNC			Max: 65535	

Details:
 See parameter P0013 (user defined parameter).

P0013[20]	User defined parameter	Datatype: U16	Unit: -	Min: 0	Level: 3
	CStat: CUT	Active: Immediately	QuickComm. No	Def: 0	
	P-Group: FUNC			Max: 65535	

Defines a limited set of parameters to which the end user will have access.

Instructions for use:

Step 1: Set P0003 = 3 (expert user)

Step 2: Go to P0013 indices 0 to 16 (user list)

Step 3: Enter into P0013 index 0 to 16 the parameters required to be visible in the user-defined list.

The following values are fixed and cannot be changed:

- P0013 index 19 = 12 (key for user defined parameter)

- P0013 index 18 = 10 (commissioning parameter filter)

- P0013 index 17 = 3 (user access level)

Step 4: Set P0003 = 0 to activate the user defined parameter.

Dependency:

First, set P0011 ("lock") to a different value than P0012 ("key") to prevent changes to user-defined parameter. Then, set P0003 to 0 to activate the user-defined list.

When locked and the user-defined parameter is activated, the only way to exit the user-defined parameter (and view other parameters) is to set P0012 ("key") to the value in P0011 ("lock").

Note:

Alternatively, set P0010 = 30 (commissioning parameter filter = factory setting) and P0970 = 1 (factory reset) to perform a complete factory reset.

The default values of P0011 ("lock") and P0012 ("key") are the same.

r0018	Firmware version	Datatype: Float	Unit: -	Min: -	Level: 1
	P-Group: INVERTER			Def: -	
				Max: -	

Displays version number of installed firmware.

r0019	CO/BO: BOP control word	Datatype: U16	Unit: -	Min: -	Level: 3
	P-Group: COMMANDS			Def: -	
				Max: -	

Displays status of operator panel commands.

The settings below are used as the "source" codes for keypad control when connecting to BICO input parameters.

Bitfields:

Bit00	ON/OFF1	0	NO
		1	YES
Bit01	OFF2: Electrical stop	0	YES
		1	NO
Bit02	OFF3: Fast stop	0	YES
		1	NO
Bit08	JOG right	0	NO
		1	YES
Bit09	JOG left	0	NO
		1	YES
Bit11	Reverse (setpoint inversion)	0	NO
		1	YES
Bit13	Motor potentiometer MOP up	0	NO
		1	YES
Bit14	Motor potentiometer MOP down	0	NO
		1	YES

Note:

When BICO technology is used to allocate functions to panel buttons, this parameter displays the actual status of the relevant command.

The following functions can be "connected" to individual buttons:

- ON/OFF1,
- OFF2,
- JOG,
- REVERSE,
- INCREASE,
- DECREASE

r0020	CO: Act. frequency setpoint	Datatype: Float	Unit: Hz	Min: -	Level: 3
	P-Group: CONTROL			Def: -	
				Max: -	

Displays actual frequency setpoint (output from ramp function generator).

r0021	CO: Act. frequency	Datatype: Float	Unit: Hz	Min: - Def: - Max: -	Level: 2
	P-Group: CONTROL				
	Displays actual inverter output frequency (r0024) excluding slip compensation, resonance damping and frequency limitation.				
r0022	Act. rotor speed	Datatype: Float	Unit: 1/min	Min: - Def: - Max: -	Level: 3
	P-Group: CONTROL				
	Displays calculated rotor speed based on inverter output frequency [Hz] x 120 / number of poles.				
	Note: This calculation makes no allowance for load-dependent slip.				
r0024	CO: Act. output frequency	Datatype: Float	Unit: Hz	Min: - Def: - Max: -	Level: 3
	P-Group: CONTROL				
	Displays actual output frequency (slip compensation, resonance damping and frequency limitation are included).				
r0025	CO: Act. output voltage	Datatype: Float	Unit: V	Min: - Def: - Max: -	Level: 2
	P-Group: CONTROL				
	Displays [rms] voltage applied to motor.				
r0026	CO: Act. DC-link voltage	Datatype: Float	Unit: V	Min: - Def: - Max: -	Level: 2
	P-Group: INVERTER				
	Displays DC-link voltage.				
r0027	CO: Act. output current	Datatype: Float	Unit: A	Min: - Def: - Max: -	Level: 2
	P-Group: CONTROL				
	Displays [rms] value of motor current [A].				
r0034	CO: Motor temperature (I2t)	Datatype: Float	Unit: %	Min: - Def: - Max: -	Level: 2
	P-Group: MOTOR				
	Displays calculated motor temperature (I2t model) as [%] of the maximum permissible value.				
	Note: A value of 100 % means that the motor has reached its maximum permissible operating temperature. In this case, the motor will attempt to reduce the motor loading as defined in P0610 (motor I2t temperature reaction).				
r0036	CO: Inverter overload utilization	Datatype: Float	Unit: %	Min: - Def: - Max: -	Level: 4
	P-Group: INVERTER				
	Displays inverter overload utilization calculated via I2t model.				
	The actual I2t value relative to the max. possible I2t value supplies utilization in [%].				
	If the nominal current of the inverter is not exceeded, 0 % utilization will be displayed.				
	If the current exceeds the threshold for P0294 (inverter I2t overload warning), warning A0504 (inverter overtemperature) is generated and the output current of the inverter reduced via P0290 (inverter overload reaction).				
	If 100 % utilization is exceeded, alarm F0005 (inverter I2T) is tripped.				
r0037	CO: Inverter temperature [°C]	Datatype: Float	Unit: °C	Min: - Def: - Max: -	Level: 3
	P-Group: INVERTER				
	Displays internal inverter heatsink temperature.				
r0039	CO: Energy consumpt. meter [kWh]	Datatype: Float	Unit: kWh	Min: - Def: - Max: -	Level: 2
	P-Group: INVERTER				
	Displays electrical energy used by inverter since display was last reset (see P0040 - reset energy consumption meter).				
	Dependency: Value is reset when P3900 = 1 (end quick commissioning), P0970 = 1 (factory reset) or P0040 = 1 (reset energy consumption meter).				

P0040	Reset energy consumption meter	Min: 0	Level: 2	
	CStat: CT	Datatype: U16		Unit: -
	P-Group: INVERTER	Active: Immediately		QuickComm. No

Resets value of parameter r0039 (energy consumption meter) to zero.

Enum:

0 No reset
1 Reset r0039 to 0

Dependency:

No reset until "P" is pressed.

r0052	CO/BO: Act. status word 1	Min: -	Level: 2	
		Datatype: U16		Unit: -
	P-Group: COMMANDS			Def: - Max: -

Displays first active status word of inverter (bit format) and can be used to diagnose inverter status. The display segments for the status word are shown in the "Introduction to MICROMASTER System Parameters".

Bitfields:

Bit00	Drive ready	0	NO
		1	YES
Bit01	Drive ready to run	0	NO
		1	YES
Bit02	Drive running	0	NO
		1	YES
Bit03	Drive fault active	0	NO
		1	YES
Bit04	OFF2 active	0	YES
		1	NO
Bit05	OFF3 active	0	YES
		1	NO
Bit06	ON inhibit active	0	NO
		1	YES
Bit07	Drive warning active	0	NO
		1	YES
Bit08	Deviation setp. / act. value	0	YES
		1	NO
Bit09	PZD control	0	NO
		1	YES
Bit10	Maximum frequency reached	0	NO
		1	YES
Bit11	Warning: Motor current limit	0	YES
		1	NO
Bit12	Motor holding brake active	0	NO
		1	YES
Bit13	Motor overload	0	YES
		1	NO
Bit14	Motor runs direction right	0	NO
		1	YES
Bit15	Inverter overload	0	YES
		1	NO

Note:

Output of Bit3 (Fault) will be inverted on digital output (Low = Fault, High = No Fault).

r0053	CO/BO: Act. status word 2	Datatype: U16	Unit: -	Min: -	Level: 2
	P-Group: COMMANDS			Def: - Max: -	

Displays second status word of inverter (in bit format).

Bitfields:

Bit00	DC brake active	0	NO
		1	YES
Bit01	Act. freq. r0024 > P2167	0	NO
		1	YES
Bit02	Act. freq. r0024 > P1080	0	NO
		1	YES
Bit03	Act. current r0027 >= P2170	0	NO
		1	YES
Bit04	Act. freq. r0024 > P2155	0	NO
		1	YES
Bit05	Act. freq. r0024 <= P2155	0	NO
		1	YES
Bit06	Act. freq. r0024 >= setpoint	0	NO
		1	YES
Bit07	Act. Vdc r0026 < P2172	0	NO
		1	YES
Bit08	Act. Vdc r0026 > P2172	0	NO
		1	YES
Bit09	Ramping finished	0	NO
		1	YES
Bit10	PID output r2294 < P2291	0	NO
		1	YES
Bit11	PID output r2294 >= P2291	0	NO
		1	YES
Bit14	Download data set 0 from AOP	0	NO
		1	YES
Bit15	Download data set 1 from AOP	0	NO
		1	YES

Details:

See description of seven-segment display given in the introduction

r0054	CO/BO: Act. control word 1	Datatype: U16	Unit: -	Min: -	Level: 3
	P-Group: COMMANDS			Def: - Max: -	

Displays first control word of inverter and can be used to diagnose which commands are active.

Bitfields:

Bit00	ON/OFF1	0	NO
		1	YES
Bit01	OFF2: Electrical stop	0	YES
		1	NO
Bit02	OFF3: Fast stop	0	YES
		1	NO
Bit03	Pulse enable	0	NO
		1	YES
Bit04	RFG enable	0	NO
		1	YES
Bit05	RFG start	0	NO
		1	YES
Bit06	Setpoint enable	0	NO
		1	YES
Bit07	Fault acknowledge	0	NO
		1	YES
Bit08	JOG right	0	NO
		1	YES
Bit09	JOG left	0	NO
		1	YES
Bit10	Control from PLC	0	NO
		1	YES
Bit11	Reverse (setpoint inversion)	0	NO
		1	YES
Bit13	Motor potentiometer MOP up	0	NO
		1	YES
Bit14	Motor potentiometer MOP down	0	NO
		1	YES
Bit15	Local / Remote	0	NO
		1	YES

Details:

See description of seven-segment display given in the introduction

r0055	CO/BO: Add. act. control word	Datatype: U16	Unit: -	Min: -	Level: 3
	P-Group: COMMANDS			Def: - Max: -	

Displays additional control word of inverter and can be used to diagnose which commands are active.

Bitfields:

Bit00	Fixed frequency Bit 0	0	NO
		1	YES
Bit01	Fixed frequency Bit 1	0	NO
		1	YES
Bit02	Fixed frequency Bit 2	0	NO
		1	YES
Bit08	PID enabled	0	NO
		1	YES
Bit09	DC brake enabled	0	NO
		1	YES
Bit13	External fault 1	0	YES
		1	NO

Details:

See description of seven-segment display given in the introduction

r0056	CO/BO: Status of motor control	Datatype: U16	Unit: -	Min: -	Level: 3
	P-Group: CONTROL			Def: - Max: -	

Displays status of motor control (MM420: V/f status), which can be used to diagnose inverter status.

Bitfields:

Bit00	Init. control finished	0	NO
		1	YES
Bit01	Motor demagnetizing finished	0	NO
		1	YES
Bit02	Pulses enabled	0	NO
		1	YES
Bit03	Voltage soft start select	0	NO
		1	YES
Bit04	Motor excitation finished	0	NO
		1	YES
Bit05	Starting boost active	0	NO
		1	YES
Bit06	Acceleration boost active	0	NO
		1	YES
Bit07	Frequency is negative	0	NO
		1	YES
Bit08	Field weakening active	0	NO
		1	YES
Bit09	Volts setpoint limited	0	NO
		1	YES
Bit10	Slip frequency limited	0	NO
		1	YES
Bit11	F_out > F_max Freq. limited	0	NO
		1	YES
Bit12	Phase reversal selected	0	NO
		1	YES
Bit13	I-max controller active	0	NO
		1	YES
Bit14	Vdc-max controller active	0	NO
		1	YES
Bit15	Vdc-min controller active	0	NO
		1	YES

Details:

See description of seven-segment display given in the introduction

r0067	CO: Act. output current limit	Datatype: Float	Unit: A	Min: -	Level: 3
	P-Group: CONTROL			Def: - Max: -	

Displays valid maximum output current of drive.

This value is influenced by P0640 (max. output current), the derating characteristics and the thermal motor and inverter protection.

Dependency:

P0610 (motor I_{2t} temperature reaction) defines reaction when limit is reached.

Note:

Normally, current limit = rated motor current (P0305) x motor current limit (P0640). It is less than or equal to maximum inverter current r0209.

The current limit may be reduced if the motor thermal model calculation indicates that overheating will occur.

r0071	CO: Max. output voltage	Datatype: Float	Unit: V	Min: - Def: - Max: -	Level: 3															
	P-Group: CONTROL																			
Displays maximum output voltage.																				
Dependency: Actual maximum output voltage depends on the actual input supply voltage.																				
r0078	CO: Act. current Isq	Datatype: Float	Unit: A	Min: - Def: - Max: -	Level: 3															
	P-Group: CONTROL																			
Displays component of torque generating current.																				
r0084	CO: Act. air gap flux	Datatype: Float	Unit: %	Min: - Def: - Max: -	Level: 4															
	P-Group: CONTROL																			
Displays air gap flux in [%] relative to the rated motor flux.																				
r0086	CO: Act. active current	Datatype: Float	Unit: A	Min: - Def: - Max: -	Level: 3															
	P-Group: CONTROL																			
Displays active (real part) of motor current.																				
Dependency: Applies when V/f control is selected in P1300 (control mode); otherwise, the display shows the value zero.																				
P0100	Europe / North America	Datatype: U16	Unit: -	Min: 0 Def: 0 Max: 2	Level: 1															
	CStat: C P-Group: QUICK	Active: Immediately	QuickComm: Yes																	
Determines whether power settings (e.g. nominal rating plate power - P0307) are expressed in [kW] or [hp].																				
The default settings for the nominal rating plate frequency (P0310) and maximum motor frequency (P1082) are also set automatically here, in addition to reference frequency (P2000).																				
Enum:																				
0 Europe [kW], frequency default 50 Hz																				
1 North America [hp], frequency default 60 Hz																				
2 North America [kW], frequency default 60 Hz																				
Dependency: The setting of DIP switch 2 under the I/O board determines the validity of settings 0 and 1 for P0100 according to the table below:																				
<table border="1"> <thead> <tr> <th>DIP 2 setting</th> <th>Meaning</th> <th></th> <th>P0100 setting</th> <th>Meaning</th> </tr> </thead> <tbody> <tr> <td>OFF</td> <td>[kW], frequency default 50 [Hz]</td> <td>overwrites</td> <td>1</td> <td>[hp], frequency default 60 [Hz]</td> </tr> <tr> <td>ON</td> <td>[hp], frequency default 60 [Hz]</td> <td>overwrites</td> <td>0</td> <td>[kW], frequency default 50 [Hz]</td> </tr> </tbody> </table>						DIP 2 setting	Meaning		P0100 setting	Meaning	OFF	[kW], frequency default 50 [Hz]	overwrites	1	[hp], frequency default 60 [Hz]	ON	[hp], frequency default 60 [Hz]	overwrites	0	[kW], frequency default 50 [Hz]
DIP 2 setting	Meaning		P0100 setting	Meaning																
OFF	[kW], frequency default 50 [Hz]	overwrites	1	[hp], frequency default 60 [Hz]																
ON	[hp], frequency default 60 [Hz]	overwrites	0	[kW], frequency default 50 [Hz]																
Stop drive first (i.e. disable all pulses) before you change this parameter.																				
P0010 = 1 (commissioning mode) enables changes to be made.																				
Changing P0100 resets all rated motor parameters as well as other parameters that depend on the rated motor parameters (see P0340 - calculation of motor parameters).																				
Notice: P0100 setting 2 (==> [kW], frequency default 60 [Hz]) is not overwritten by the setting of DIP switch 2 (see table above).																				
r0200	Act. power stack code number	Datatype: U32	Unit: -	Min: - Def: - Max: -	Level: 3															
	P-Group: INVERTER																			
Identifies hardware variant as shown in table below.																				
Notice: Parameter r0200 = 0 indicates that no power stack has been identified.																				
P0201	Power stack code number	Datatype: U16	Unit: -	Min: 0 Def: 0 Max: 65535	Level: 3															
	CStat: C P-Group: INVERTER	Active: Immediately	QuickComm: No																	
Confirms actual power stack identified.																				

r0203	Act. inverter type	Datatype: U16	Unit: -	Min: - Def: - Max: -	Level: 3
	P-Group: INVERTER				
	Type number of actual power stack identified.				
Enum:					
	1	MICROMASTER 420			
	2	MICROMASTER 440			
	3	MICRO- / COMBIMASTER 411			
	4	MICROMASTER 410			
	5	Reserved			
r0204	Power stack features	Datatype: U32	Unit: -	Min: - Def: - Max: -	Level: 3
	P-Group: INVERTER				
	Displays hardware features of power stack.				
Bitfields:					
	Bit00	DC input voltage	0	NO	
			1	YES	
	Bit01	RFI filter	0	NO	
			1	YES	
Note:	Parameter r0204 = 0 indicates that no power stack has been identified.				
r0206	Rated inverter power [kW] / [hp]	Datatype: Float	Unit: -	Min: - Def: - Max: -	Level: 2
	P-Group: INVERTER				
	Displays nominal rated motor power from inverter.				
Dependency:	Value is displayed in [kW] or [hp] depending on setting for P0100 (operation for Europe / North America).				
r0207	Rated inverter current	Datatype: Float	Unit: A	Min: - Def: - Max: -	Level: 2
	P-Group: INVERTER				
	Displays maximum continuous output current of inverter.				
r0208	Rated inverter voltage	Datatype: U32	Unit: V	Min: - Def: - Max: -	Level: 2
	P-Group: INVERTER				
	Displays nominal AC supply voltage of inverter.				
Value:	r0208 = 230 : 200 - 240 V +/- 10 % r0208 = 400 : 380 - 480 V +/- 10 % r0208 = 575 : 500 - 600 V +/- 10 %				
r0209	Maximum inverter current	Datatype: Float	Unit: A	Min: - Def: - Max: -	Level: 2
	P-Group: INVERTER				
	Displays maximum output current of inverter.				
P0210	Supply voltage	Datatype: U16	Unit: V	Min: 0 Def: 230 Max: 1000	Level: 3
	CStat: CT P-Group: INVERTER Active: first confirm QuickComm. No				
	Optimizes Vdc controller, which extends the ramp-down time if regenerative energy from motor would otherwise cause DC link overvoltage trips.				
	Reducing the value enables controller to cut in earlier and reduce the risk of overvoltage.				
Dependency:	Set P1254 ("Auto detect Vdc switch-on levels") = 0. Cut-in levels for Vdc-controller and compound braking are then derived directly from P0210 (supply voltage).				
Note:	If mains voltage is higher than value entered, automatic deactivation of the Vdc controller may occur to avoid acceleration of the motor. An alarm will be issued in this case (A0910).				

r0231[2]	Max. cable length	Datatype: U16	Unit: m	Min: - Def: - Max: -	Level: 3
	P-Group: INVERTER				
	Indexed parameter to display maximum allowable cable length between inverter and motor.				
Index:	r0231[0] : Max. allowed unscreened cable length r0231[1] : Max. allowed screened cable length				
Notice:	For full EMC compliance, the screened cable must not exceed 25 m in length when an EMC filter is fitted.				
P0290	Inverter overload reaction	Datatype: U16	Unit: -	Min: 0 Def: 2 Max: 3	Level: 3
	CStat: CT	Datatype: U16	Unit: -	Def: 2	
	P-Group: INVERTER	Active: Immediately	QuickComm. No	Max: 3	
	Selects reaction of inverter to an internal over-temperature.				
Enum:	0 Reduce output frequency (usually only effective on variable torque appl.) 1 Trip (F0004) 2 Reduce pulse frequency and output frequency 3 Reduce pulse frequency then trip (F0004)				
Notice:	A trip will always result eventually, if the action taken does not sufficiently reduce internal temperature. The pulse frequency is normally reduced only if higher than 2 kHz (see P0291 - configuration of inverter protection).				
P0291	Config. of inverter protection	Datatype: U16	Unit: -	Min: 0 Def: 1 Max: 1	Level: 4
	CStat: CT	Datatype: U16	Unit: -	Def: 1	
	P-Group: INVERTER	Active: first confirm	QuickComm. No	Max: 1	
	Control bit for enabling/disabling automatic pulse frequency reduction at output frequencies below 2 Hz.				
Bitfields:	Bit00 Pulse freq reduced below 2Hz 0 NO 1 YES				
Details:	See P0290 (inverter overload reaction)				
P0292	Inverter overload warning	Datatype: U16	Unit: °C	Min: 0 Def: 15 Max: 25	Level: 3
	CStat: CUT	Datatype: U16	Unit: °C	Def: 15	
	P-Group: INVERTER	Active: Immediately	QuickComm. No	Max: 25	
	Defines temperature difference (in [°C]) between inverter over-temperature trip and warning thresholds.				
P0294	Inverter I2t overload warning	Datatype: Float	Unit: %	Min: 10.0 Def: 95.0 Max: 100.0	Level: 4
	CStat: CUT	Datatype: Float	Unit: %	Def: 95.0	
	P-Group: INVERTER	Active: Immediately	QuickComm. No	Max: 100.0	
	Defines the [%] value at which warning A0504 (inverter overtemperature) is generated. Inverter I2t calculation is used to estimate a maximum tolerable period for inverter overload. The I2t calculation value is deemed = 100 % when this maximum tolerable period is reached.				
Dependency:	Motor overload factor (P0640) reduced to 100 % at this point.				
Note:	P0294 = 100 % corresponds to stationary nominal load.				
P0295	Inverter fan off delay time	Datatype: U16	Unit: s	Min: 0 Def: 0 Max: 3600	Level: 3
	CStat: CUT	Datatype: U16	Unit: s	Def: 0	
	P-Group: TERMINAL	Active: Immediately	QuickComm. No	Max: 3600	
	Defines inverter fan switch off delay time in seconds after drive has stopped.				
Note:	Setting to 0, inverter fan will switch off when the drive stops, that is no delay.				

P0300	Select motor type			Min: 1	Level: 2
	CStat: C	Datatype: U16	Unit: -	Def: 1	
	P-Group: MOTOR	Active: Immediately	QuickComm: Yes	Max: 2	

Selects motor type.

This parameter is required during commissioning to select motor type and optimize inverter performance. Most motors are asynchronous; if in doubt, use the formula below.
(rated motor frequency (P0310) * 60) / rated motor speed (P0311)

If the result is a whole number, the motor is synchronous.

Enum:

- 1 Asynchronous motor
- 2 Synchronous motor

Dependency:

Changeable only when P0010 = 1 (quick commissioning).

If synchronous motor is selected, the following functions are not available:

Power factor (P0308)
Motor efficiency (P0309)
Magnetization time (P0346 (Level 3))
Demagnetization time (P0347 (Level 3))
Flying start (P1200, P1202 (Level 3), P1203 (Level 3))
DC braking (P1230 (Level 3), P1232, P1233)
Slip compensation (P1335)
Slip limit (P1336)
Motor magnetizing current (P0320 (Level 3)),
Rated motor slip (P0330),
Rated magnetization current (P0331),
Rated power factor (P0332),
Rotor time constant (P0384)

P0304	Rated motor voltage			Min: 10	Level: 1
	CStat: C	Datatype: U16	Unit: V	Def: 230	
	P-Group: MOTOR	Active: Immediately	QuickComm: Yes	Max: 2000	

Nominal motor voltage [V] from rating plate. Following diagram shows a typical rating plate with the locations of the relevant motor data.

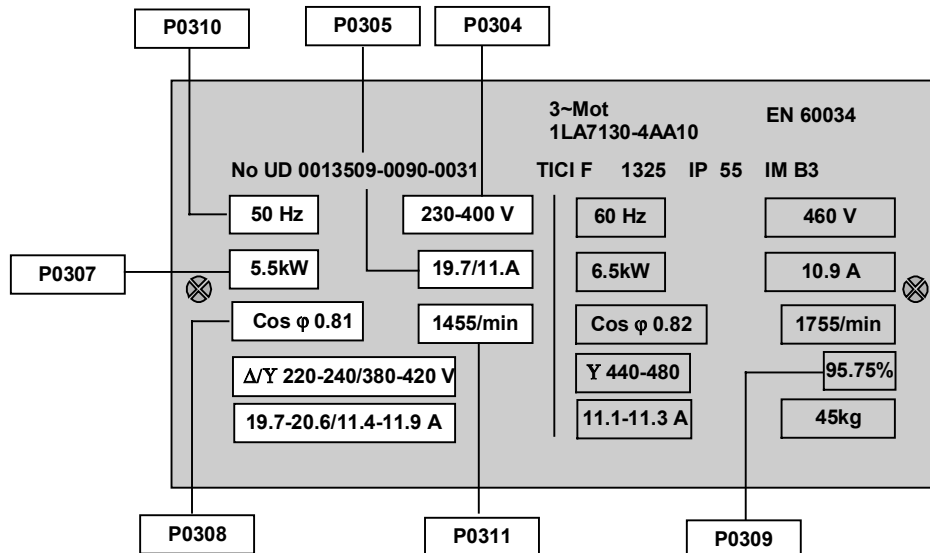
**Dependency:**

Changeable only when P0010 = 1 (quick commissioning).

P0305	Rated motor current	Min: 0.01	Level:
	CStat: C Datatype: Float Unit: A Def: 3.25		1
	P-Group: MOTOR Active: Immediately QuickComm. Yes Max: 10000.00		
	Nominal motor current [A] from rating plate - see diagram in P0304.		
	Dependency: Changeable only when P0010 = 1 (quick commissioning).		
	Depends also on P0320 (motor magnetization current).		
	Note: For asynchronous motors, the maximum value is defined as the maximum inverter current (r0209). For synchronous motors, the maximum value is defined as twice the maximum inverter current (r0209). The minimum value is defined as 1/32 times inverter rated current (r0207).		
P0307	Rated motor power	Min: 0.01	Level:
	CStat: C Datatype: Float Unit: - Def: 0.75		1
	P-Group: MOTOR Active: Immediately QuickComm. Yes Max: 2000.00		
	Nominal motor power [kW/hp] from rating plate.		
	Dependency: If P0100 = 1 ([kW], frequency default 50 Hz), values will be in [hp] - see diagram P0304 (rating plate). Changeable only when P0010 = 1 (quick commissioning).		
P0308	Rated motor cosPhi	Min: 0.000	Level:
	CStat: C Datatype: Float Unit: - Def: 0.000		2
	P-Group: MOTOR Active: Immediately QuickComm. Yes Max: 1.000		
	Nominal motor power factor (cosPhi) from rating plate - see diagram P0304.		
	Dependency: Changeable only when P0010 = 1 (quick commissioning). Visible only when P0100 = 0 or 2, (motor power entered in [kW]). Setting 0 causes internal calculation of value (see r0332).		
P0309	Rated motor efficiency	Min: 0.0	Level:
	CStat: C Datatype: Float Unit: % Def: 0.0		2
	P-Group: MOTOR Active: Immediately QuickComm. Yes Max: 99.9		
	Nominal motor efficiency in [%] from rating plate.		
	Dependency: Changeable only when P0010 = 1 (quick commissioning). Visible only when P0100 = 1, (i.e. motor power entered in [hp]). Setting 0 causes internal calculation of value (see r0332).		
	Note: P0309 = 100 % corresponds to superconducting.		
	Details: See diagram in P0304 (rating plate)		
P0310	Rated motor frequency	Min: 12.00	Level:
	CStat: C Datatype: Float Unit: Hz Def: 50.00		1
	P-Group: MOTOR Active: Immediately QuickComm. Yes Max: 650.00		
	Nominal motor frequency [Hz] from rating plate.		
	Dependency: Changeable only when P0010 = 1 (quick commissioning). Pole pair number recalculated automatically if parameter is changed.		
	Details: See diagram in P0304 (rating plate)		

P0311	Rated motor speed	CStat: C P-Group: MOTOR	Datatype: U16 Active: Immediately	Unit: 1/min QuickComm. Yes	Min: 0 Def: 0 Max: 40000	Level: 1
	Nominal motor speed [rpm] from rating plate.					
	Dependency: Changeable only when P0010 = 1 (quick commissioning).					
	Setting 0 causes internal calculation of value.					
	Required for vector control and V/f control with speed controller.					
	Slip compensation in V/f control requires rated motor speed for correct operation.					
	Pole pair number recalculated automatically if parameter is changed.					
	Details: See diagram in P0304 (rating plate)					
r0313	Motor pole pairs	P-Group: MOTOR	Datatype: U16	Unit: -	Min: - Def: - Max: -	Level: 3
	Displays number of motor pole pairs that the inverter is currently using for internal calculations.					
	Value: r0313 = 1 : 2-pole motor r0313 = 2 : 4-pole motor etc.					
	Dependency: Recalculated automatically when P0310 (rated motor frequency) or P0311 (rated motor speed) is changed.					
P0320	Motor magnetizing current	CStat: CT P-Group: MOTOR	Datatype: Float Active: first confirm	Unit: % QuickComm. Yes	Min: 0.0 Def: 0.0 Max: 99.0	Level: 3
	Defines motor magnetization current in [%] relative to P0305 (rated motor current).					
	Dependency: Affected by P0366 - P0369 (magnetizing curve imag. 1 - 4) Setting 0 causes calculation by P0340 = 1 (data entered from rating plate) or by P3900 = 1 or 2 (end of quick commissioning).					
r0330	Rated motor slip	P-Group: MOTOR	Datatype: Float	Unit: %	Min: - Def: - Max: -	Level: 3
	Displays nominal motor slip in [%] relative to P0310 (rated motor frequency) and P0311 (rated motor speed).					
r0331	Rated magnetization current	P-Group: MOTOR	Datatype: Float	Unit: A	Min: - Def: - Max: -	Level: 3
	Displays calculated magnetizing current of motor in [A].					
r0332	Rated power factor	P-Group: MOTOR	Datatype: Float	Unit: -	Min: - Def: - Max: -	Level: 3
	Displays power factor for motor					
	Dependency: Value is calculated internally if P0308 (rated motor cosPhi) set to 0; otherwise, value entered in P0308 is displayed.					
P0335	Motor cooling	CStat: CT P-Group: MOTOR	Datatype: U16 Active: Immediately	Unit: - QuickComm. Yes	Min: 0 Def: 0 Max: 1	Level: 2
	Selects motor cooling system used.					
	Enum: 0 Self-cooled: Using shaft mounted fan attached to motor 1 Force-cooled: Using separately powered cooling fan					
	Notice: Motors of series 1LA1 and 1LA8 have an internal fan. This internal motor fan must not be confused with the fan at the end of the motor shaft.					

P0340	Calculation of motor parameters	Min: 0	Level:
	CStat: CT Datatype: U16 Unit: - Def: 0 P-Group: MOTOR Active: Immediately QuickComm. No Max: 1		2
Calculates various motor parameters, including:			
Motor weight P0344 (Level 3)			
Magnetization time P0346 (Level 3)			
Demagnetization time P0347 (Level 3)			
Stator resistance P0350 (Level 2)			
Reference frequency P2000 (Level 2)			
Reference current P2002 (Level 3).			
Enum:			
0 No calculation			
1 Complete parameterization			
Note:			
This parameter is required during commissioning to optimize inverter performance.			
P0344	Motor weight	Min: 1.0	Level:
	CStat: CUT Datatype: Float Unit: kg Def: 9.4 P-Group: MOTOR Active: first confirm QuickComm. No Max: 6500.0		3
Specifies motor weight [kg].			
Note:			
This value is used in the motor thermal model.			
It is normally calculated automatically from P0340 (motor parameters) but can also be entered manually.			
P0346	Magnetization time	Min: 0.000	Level:
	CStat: CUT Datatype: Float Unit: s Def: 1.000 P-Group: MOTOR Active: first confirm QuickComm. No Max: 20.000		3
Sets magnetization time [s], i.e. waiting time between pulse enable and start of ramp-up. Motor magnetization builds up during this time.			
Magnetization time is normally calculated automatically from the motor data and corresponds to the rotor time constant (r0384).			
Note:			
If boost settings are higher than 100 %, magnetization may be reduced.			
Notice:			
An excessive reduction of this time can result in insufficient motor magnetization.			
P0347	Demagnetization time	Min: 0.000	Level:
	CStat: CUT Datatype: Float Unit: s Def: 1.000 P-Group: MOTOR Active: first confirm QuickComm. No Max: 20.000		3
Changes time allowed after OFF2 / fault condition, before pulses can be re-enabled.			
Note:			
The demagnetization time is approximately 2.5 x rotor time constant (r0384) in seconds.			
Notice:			
Not active following a normally completed ramp-down, e.g. after OFF1, OFF3 or JOG.			
Overcurrent trips will occur if the time is decreased excessively.			
P0350	Stator resistance (line-to-line)	Min: 0.00001	Level:
	CStat: CUT Datatype: Float Unit: Ohm Def: 4.0 P-Group: MOTOR Active: first confirm QuickComm. No Max: 2000.0		2
Stator resistance value in [Ohms] for connected motor (from line-to-line). The parameter value includes the cable resistance.			
There are three ways to determine the value for this parameter:			
1. Calculate using P0340 = 1 (data entered from rating plate) or P3900 = 1,2 or 3 (end of quick commissioning)			
2. Measure using P1910 = 1 (motor data identification - value for stator resistance is overwritten)			
3. Measure manually using an Ohmmeter.			
Note:			
Since measured line-to-line, this value may appear to be higher (up to 2 times higher) than expected.			
The value entered in P0350 (stator resistance) is the one obtained by the method last used.			
r0370	Stator resistance [%]	Min: -	Level:
	Datatype: Float Unit: % Def: - P-Group: MOTOR Max: -		4
Displays standardized stator resistance of motor equivalent circuit (phase value) in [%].			
Note:			
100 % means : $Z_{ratedmot} * \frac{P0304}{P0305}$			

r0372	Cable resistance [%]	Datatype: Float	Unit: %	Min: - Def: - Max: -	Level: 4
	P-Group: MOTOR				
	Displays standardized cable resistance of motor equivalent circuit (phase value) in [%]. It is estimated to be 20 % of the stator resistance.				
	Note:				
	100 % means : $Z_{\text{ratedmot}} * \frac{P0304}{P0305}$				
r0373	Rated stator resistance [%]	Datatype: Float	Unit: %	Min: - Def: - Max: -	Level: 4
	P-Group: MOTOR				
	Displays rated stator resistance of the motor equivalent circuit (phase value) in [%].				
	Note:				
	100 % means : $Z_{\text{ratedmot}} * \frac{P0304}{P0305}$				
r0374	Rotor resistance [%]	Datatype: Float	Unit: %	Min: - Def: - Max: -	Level: 4
	P-Group: MOTOR				
	Displays standardized rotor resistance of the motor equivalent circuit (phase value) in [%].				
	Note:				
	100 % means : $Z_{\text{ratedmot}} * \frac{P0304}{P0305}$				
r0376	Rated rotor resistance [%]	Datatype: Float	Unit: %	Min: - Def: - Max: -	Level: 4
	P-Group: MOTOR				
	Displays rated rotor resistance of the motor equivalent circuit (phase value) in [%].				
	Note:				
	100 % means : $Z_{\text{ratedmot}} * \frac{P0304}{P0305}$				
r0377	Total leakage reactance [%]	Datatype: Float	Unit: %	Min: - Def: - Max: -	Level: 4
	P-Group: MOTOR				
	Displays standardized total leakage reactance of the motor equivalent circuit (phase value) in [%].				
	Note:				
	100 % means : $Z_{\text{ratedmot}} * \frac{P0304}{P0305}$				
r0382	Main reactance [%]	Datatype: Float	Unit: %	Min: - Def: - Max: -	Level: 4
	P-Group: MOTOR				
	Displays standardized main reactance of the motor equivalent circuit (phase value) in [%].				
	Note:				
	100 % means : $Z_{\text{ratedmot}} * \frac{P0304}{P0305}$				
r0384	Rotor time constant	Datatype: Float	Unit: ms	Min: - Def: - Max: -	Level: 3
	P-Group: MOTOR				
	Displays calculated rotor time constant [ms].				
r0386	Total leakage time constant	Datatype: Float	Unit: ms	Min: - Def: - Max: -	Level: 4
	P-Group: MOTOR				
	Displays total leakage time constant of motor.				
r0395	CO: Total stator resistance [%]	Datatype: Float	Unit: %	Min: - Def: - Max: -	Level: 3
	P-Group: MOTOR				
	Displays stator resistance of motor as [%] of combined stator/cable resistance.				
	Note:				
	100 % means : $Z_{\text{ratedmot}} * \frac{P0304}{P0305}$				

P0610	Motor I2t temperature reaction				Min: 0	Level: 3
	CStat: CT	Datatype: U16	Unit: -	Def: 2	Max: 2	
	P-Group: MOTOR	Active: Immediately	QuickComm. No	Max: 2		
	Defines reaction when motor I2t reaches warning threshold.					
	Enum:					
	0	No reaction, warning only				
	1	Warning and I _{max} reduction (results in reduced output freq.)				
	2	Warning and trip (F0011)				
	Dependency:					
	Trip level = P0614 (motor I2t overload warning level) * 110 %					
P0611	Motor I2t time constant				Min: 0	Level: 2
	CStat: CT	Datatype: U16	Unit: s	Def: 100	Max: 16000	
	P-Group: MOTOR	Active: first confirm	QuickComm. No	Max: 16000		
	Defines motor thermal time constant and is calculated automatically from the motor data (see P0340).					
	Notice:					
	A larger number increases the time taken for the calculated motor temperature to change.					
P0614	Motor I2t overload warning level				Min: 0.0	Level: 2
	CStat: CUT	Datatype: Float	Unit: %	Def: 100.0	Max: 400.0	
	P-Group: MOTOR	Active: Immediately	QuickComm. No	Max: 400.0		
	Defines the [%] value at which warning A0511 (inverter overtemperature) is generated.					
	Inverter I2t calculation is used to estimate a maximum tolerable period (i.e. without overheating) for inverter overload. The I2t calculation value is deemed = 100 % when this maximum tolerable period is reached (see r0034).					
	Dependency:					
	A motor over-temperature trip (F0011) is produced at 110 % of this level.					
P0640	Motor overload factor [%]				Min: 10.0	Level: 2
	CStat: CUT	Datatype: Float	Unit: %	Def: 150.0	Max: 400.0	
	P-Group: MOTOR	Active: first confirm	QuickComm. Yes	Max: 400.0		
	Defines motor overload current limit in [%] relative to P0305 (rated motor current). current.					
	Dependency:					
	Limited to maximum inverter current or to 400 % of rated motor current (P0305), whichever is the lower.					
	Details:					
	See function diagram for current limitation.					
P0700	Selection of command source				Min: 0	Level: 1
	CStat: CT	Datatype: U16	Unit: -	Def: 2	Max: 6	
	P-Group: COMMANDS	Active: Immediately	QuickComm. Yes	Max: 6		
	Selects digital command source.					
	Enum:					
	0	Factory default setting				
	1	BOP (keypad)				
	2	Terminal				
	4	USS on BOP link				
	5	USS on COM link				
	6	CB on COM link				
	Note:					
	Changing this parameter resets (to default) all settings on item selected. For example: Changing from 1 to 2 resets all digital inputs to default settings.					

P0701	Function of digital input 1				Min: 0	Level: 2
	CStat: CT	Datatype: U16	Unit: -	Def: 1		
	P-Group: COMMANDS	Active: Immediately	QuickComm. No	Max: 99		

Selects function of digital input 1.

Enum:

0	Digital input disabled
1	ON/OFF1
2	ON reverse /OFF1
3	OFF2 - coast to standstill
4	OFF3 - quick ramp-down
9	Fault acknowledge
10	JOG right
11	JOG left
12	Reverse
13	MOP up (increase freq.)
14	MOP down (decrease freq.)
15	Fixed setpoint (Direct selection)
16	Fixed setpoint (Direct selection + ON)
17	Fixed setpoint (Binary coded selection + ON)
25	DC brake enable
29	External trip
33	Disable additional freq setpoint
99	Enable BICO parameterization

Dependency:

Setting 99 (enable BICO parameterization) requires P0700 (command source) or P3900 (end of quick commissioning) = 1, 2 or P0970 (factory reset) = 1 in order to reset.

Notice:

Setting 99 (BICO) for expert use only.

P0702	Function of digital input 2				Min: 0	Level: 2
	CStat: CT	Datatype: U16	Unit: -	Def: 12		
	P-Group: COMMANDS	Active: Immediately	QuickComm. No	Max: 99		

Selects function of digital input 2.

Enum:

0	Digital input disabled
1	ON/OFF1
2	ON reverse /OFF1
3	OFF2 - coast to standstill
4	OFF3 - quick ramp-down
9	Fault acknowledge
10	JOG right
11	JOG left
12	Reverse
13	MOP up (increase freq.)
14	MOP down (decrease freq.)
15	Fixed setpoint (Direct selection)
16	Fixed setpoint (Direct selection + ON)
17	Fixed setpoint (Binary coded selection + ON)
25	DC brake enable
29	External trip
33	Disable additional freq setpoint
99	Enable BICO parameterization

Details:

See P0701 (function of digital input1).

P0703	Function of digital input 3				Min: 0	Level: 2
	CStat: CT	Datatype: U16	Unit: -	Def: 9		
	P-Group: COMMANDS	Active: Immediately	QuickComm. No	Max: 99		

Selects function of digital input 3.

Enum:

0	Digital input disabled
1	ON/OFF1
2	ON reverse /OFF1
3	OFF2 - coast to standstill
4	OFF3 - quick ramp-down
9	Fault acknowledge
10	JOG right
11	JOG left
12	Reverse
13	MOP up (increase freq.)
14	MOP down (decrease freq.)
15	Fixed setpoint (Direct selection)
16	Fixed setpoint (Direct selection + ON)
17	Fixed setpoint (Binary coded selection + ON)
25	DC brake enable
29	External trip
33	Disable additional freq setpoint
99	Enable BICO parameterization

Details:

See P0701 (function of digital input 1).

P0704	Function of digital input 4				Min: 0	Level: 2
	CStat: CT	Datatype: U16	Unit: -	Def: 0		
	P-Group: COMMANDS	Active: Immediately	QuickComm. No	Max: 99		

Selects function of digital input 4 (via analog input).

Enum:

0	Digital input disabled
1	ON/OFF1
2	ON reverse /OFF1
3	OFF2 - coast to standstill
4	OFF3 - quick ramp-down
9	Fault acknowledge
10	JOG right
11	JOG left
12	Reverse
13	MOP up (increase freq.)
14	MOP down (decrease freq.)
21	Local/remote
25	DC brake enable
29	External trip
33	Disable additional freq setpoint
99	Enable BICO parameterization

Details:

See P0701 (function of digital input 1).

P0719	Selection of cmd. & freq. setp.				Min: 0	Level: 3
	CStat: CT	Datatype: U8	Unit: -	Def: 0		
	P-Group: COMMANDS	Active: *	QuickComm.: -	Max: 66		

Central switch to select control command source for inverter.

Switch the command and setpoint source between free programable BICO parameters and fixed command/setpoint profiles. Command and setpoint source can be changed independently.

The tens digit chooses the command source and the once digit choose the setpoint source.

Enum:

0	"Cmd = BICO parameter	Setpoint = BICO parameter"
1	"Cmd = BICO parameter	Setpoint = MOP setpoint"
2	"Cmd = BICO parameter	Setpoint = Analog setpoint"
3	"Cmd = BICO parameter	Setpoint = Fixed frequency"
4	"Cmd = BICO parameter	Setpoint = USS on BOP-Link"
5	"Cmd = BICO parameter	Setpoint = USS on COM-Link"
6	"Cmd = BICO parameter	Setpoint = CB on COM-Link"
10	"Cmd = BOP	Setpoint = BICO parameter"
11	"Cmd = BOP	Setpoint = MOP setpoint"
12	"Cmd = BOP	Setpoint = Analog setpoint"
13	"Cmd = BOP	Setpoint = Fixed frequency"
14	"Cmd = BOP	Setpoint = USS on BOP-Link"
15	"Cmd = BOP	Setpoint = USS on COM-Link"
16	"Cmd = BOP	Setpoint = CB on COM-Link"
40	"Cmd = USS on BOP-Link	Setpoint = BICO parameter"
41	"Cmd = USS on BOP-Link	Setpoint = MOP setpoint"
42	"Cmd = USS on BOP-Link	Setpoint = Analog setpoint"
43	"Cmd = USS on BOP-Link	Setpoint = Fixed frequency"
44	"Cmd = USS on BOP-Link	Setpoint = USS on BOP-Link"
45	"Cmd = USS on BOP-Link	Setpoint = USS on COM-Link"
46	"Cmd = USS on BOP-Link	Setpoint = CB on COM-Link"
50	"Cmd = USS on COM-Link	Setpoint = BICO parameter"
51	"Cmd = USS on COM-Link	Setpoint = MOP setpoint"
52	"Cmd = USS on COM-Link	Setpoint = Analog setpoint"
53	"Cmd = USS on COM-Link	Setpoint = Fixed frequency"
54	"Cmd = USS on COM-Link	Setpoint = USS on BOP-Link"
55	"Cmd = USS on COM-Link	Setpoint = USS on COM-Link"
56	"Cmd = USS on COM-Link	Setpoint = CB on COM-Link"
60	"Cmd = CB on COM-Link	Setpoint = BICO parameter"
61	"Cmd = CB on COM-Link	Setpoint = MOP setpoint"
62	"Cmd = CB on COM-Link	Setpoint = Analog setpoint"
63	"Cmd = CB on COM-Link	Setpoint = Fixed frequency"
64	"Cmd = CB on COM-Link	Setpoint = USS on BOP-Link"
65	"Cmd = CB on COM-Link	Setpoint = USS on COM-Link"
66	"Cmd = CB on COM-Link	Setpoint = CB on COM-Link"

Note:

Note: - This parameter does not change any previously made BICO connections !

r0720	Number of digital inputs				Min: -	Level: 3
	Datatype: U16	Unit: -	Def: -	Max: -		
	P-Group: COMMANDS					

Displays number of digital inputs.

r0722	CO/BO: Binary input values				Min: -	Level: 2
	Datatype: U16	Unit: -	Def: -	Max: -		
	P-Group: COMMANDS					

Displays status of digital inputs.

Bitfields:

Bit00	Digital input 1	0	OFF
		1	ON
Bit01	Digital input 2	0	OFF
		1	ON
Bit02	Digital input 3	0	OFF
		1	ON
Bit03	Digital input 4 (via ADC)	0	OFF
		1	ON

Note:

Segment is lit when signal is active.

P0724	Debounce time for digital inputs				Min: 0	Level: 3
	CStat: CT	Datatype: U16	Unit: -	Def: 3		
	P-Group: COMMANDS	Active: first confirm	QuickComm. No	Max: 3		

Defines debounce time (filtering time) used for digital inputs.

Enum:

- 0 No debounce time
- 1 2.5 ms debounce time
- 2 8.2 ms debounce time
- 3 12.3 ms debounce time

P0725	PNP / NPN digital inputs				Min: 0	Level: 3
	CStat: CT	Datatype: U16	Unit: -	Def: 1		
	P-Group: COMMANDS	Active: first confirm	QuickComm. No	Max: 1		

Switches between active high (PNP) and active low (NPN). This is valid for all digital inputs simultaneously.

The following is valid by using the internal supply:

Value:

- NPN: Terminals 5/6/7 must be connected via terminal 9 (0 V).
- PNP: Terminals 5/6/7 must be connected via terminal 8 (24 V).

Enum:

- 0 NPN mode ==> low active
- 1 PNP mode ==> high active

r0730	Number of digital outputs				Min: -	Level: 3
	Datatype: U16		Unit: -	Def: -		
	P-Group: COMMANDS			Max: -		

Displays number of digital outputs (relays).

P0731	BI: Function of digital output 1				Min: 0:0	Level: 2
	CStat: CUT	Datatype: U32	Unit: -	Def: 52:3		
	P-Group: COMMANDS	Active: Immediately	QuickComm. No	Max: 4000:0		

Defines source of digital output 1.

Settings:

- 52.0 Drive ready 0 Closed
- 52.1 Drive ready to run 0 Closed
- 52.2 Drive running 0 Closed
- 52.3 Drive fault active 0 Closed
- 52.4 OFF2 active 1 Closed
- 52.5 OFF3 active 1 Closed
- 52.6 Switch on inhibit active 0 Closed
- 52.7 Drive warning active 0 Closed
- 52.8 Deviation setpoint/actual value 1 Closed
- 52.9 PZD control (Process Data Control) 0 Closed
- 52.A Maximum frequency reached 0 Closed
- 52.B Warning: Motor current limit 1 Closed
- 52.C Motor holding brake (MHB) active 0 Closed
- 52.D Motor overload 1 Closed
- 52.E Motor running direction right 0 Closed
- 52.F Inverter overload 1 Closed
- 53.0 DC brake active 0 Closed
- 53.1 Inverter freq. less switch off limit 0 Closed
- 53.2 Inverter freq. less minimum freq. 0 Closed
- 53.3 Current greater or equal than limit 0 Closed
- 53.4 Act. freq. greater comparison freq. 0 Closed
- 53.5 Act. freq. less comparison freq. 0 Closed
- 53.6 Act. freq. greater/equal setpoint 0 Closed
- 53.7 Voltage less than threshold 0 Closed
- 53.8 Voltage greater than threshold 0 Closed
- 53.A PID output at lower limit (P2292) 0 Closed
- 53.B PID output at upper limit (P2291) 0 Closed

r0747	CO/BO: State of digital outputs				Min: -	Level: 3
	Datatype: U16		Unit: -	Def: -		
	P-Group: COMMANDS			Max: -		

Displays status of digital outputs (also includes inversion of digital outputs via P0748).

Bitfields:

- Bit00 Digital output 1 energized 0 NO
- 1 YES

Dependency:

- Bit 0 0 = relay de-energized / contacts open
- 1 = relay energized / contacts closed

P0756	Type of ADC	Datatype: U16	Unit: -	Min: 0	Level: 2
	CStat: CT	Active: Immediately	QuickComm. No	Def: 0	
	P-Group: TERMINAL			Max: 1	

Defines type of analog input and also enables analog input monitoring.

Enum:

- 0 Unipolar voltage input (0 to +10 V)
- 1 Unipolar voltage input with monitoring (0 to 10 V)

Dependency:

Function disabled if analog scaling block programmed to output negative setpoints (see P0757 to P0760).

Notice:

When monitoring is enabled and a deadband defined (P0761), a fault condition will be generated (F0080) if the analog input voltage falls below 50 % of the deadband voltage.

Details:

See P0757 to P0760 (ADC scaling).

P0757	Value x1 of ADC scaling [V]	Datatype: Float	Unit: V	Min: 0	Level: 2
	CStat: CUT	Active: Immediately	QuickComm. No	Def: 0	
	P-Group: TERMINAL			Max: 10	

Parameters P0757 - P0760 configure the input scaling as shown in the diagram:

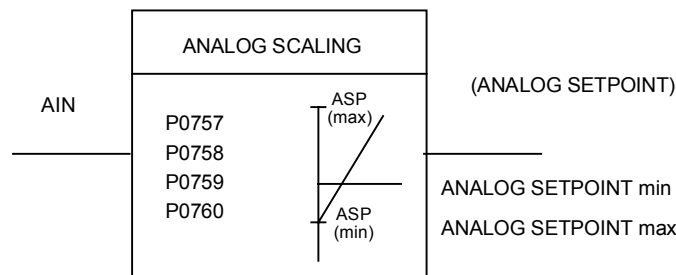

Where:

- Analog setpoints represent a [%] of the normalized frequency in P2000.
- Analog setpoints may be larger than 100 %
- ASPmax represents highest analog setpoint (this may be at 10 V).
- ASPmin represents lowest analog setpoint (this may be at 0 V).
- Default values provide a scaling of 0 V = 0 %, and 10 V = 100 %.

P0758	Value y1 of ADC scaling	Datatype: Float	Unit: %	Min: -99999.9	Level: 2
	CStat: CUT	Active: Immediately	QuickComm. No	Def: 0.0	
	P-Group: TERMINAL			Max: 99999.9	

Sets value of Y1 in [%] as described in P0757 (ADC scaling)

Dependency:

Affects P2000 to P2003 (reference frequency, voltage, current or torque) depending on which setpoint is to be generated.

P0759	Value x2 of ADC scaling [V]	Datatype: Float	Unit: V	Min: 0	Level: 2
	CStat: CUT	Active: Immediately	QuickComm. No	Def: 10	
	P-Group: TERMINAL			Max: 10	

Sets value of X2 as described in P0757 (ADC scaling)

P0760	Value y2 of ADC scaling	Datatype: Float	Unit: %	Min: -99999.9	Level: 2
	CStat: CUT	Active: Immediately	QuickComm. No	Def: 100.0	
	P-Group: TERMINAL			Max: 99999.9	

Sets value of Y2 in [%] as described in P0757 (ADC scaling)

Dependency:

Affects P2000 to P2003 (reference frequency, voltage, current or torque) depending on which setpoint is to be generated.

P0761	Width of ADC deadband [V]			Min: 0	Level: 2
	CStat: CUT	Datatype: Float	Unit: V	Def: 0	
	P-Group: TERMINAL	Active: Immediately	QuickComm. No	Max: 10	

Defines width of deadband on analog input. The diagrams below explain its use

Example:

ADC value 2 to 10 V (0 to 50 Hz)
 The above example produces a 2 to 10 V analog input (0 to 50 Hz)
 P0757 = 2 V P0761 = 2 V P2000 = 50 Hz

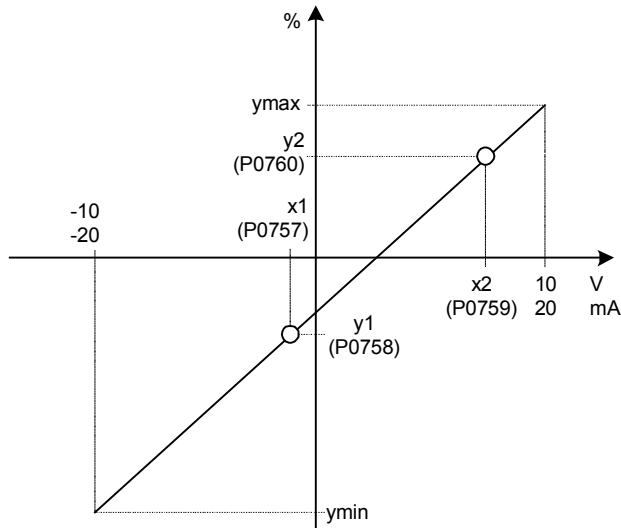

ADC value 2 to 10 V (-50 to +50 Hz)
 The above example produces a 2 to 10 V analog input (-50 to +50 Hz) with center zero and a "holding point" 0.2 V wide.
 P0758 = -100 % P0761 = 0.1 (0.1 V to each side of center)

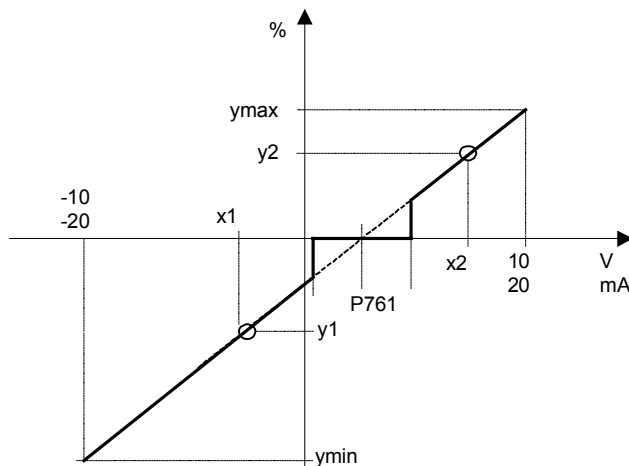

Note:

P0761[x] = 0 : No deadband active.

Notice:

Deadband starts from 0 V to value of P0761, if both values of P0758 and P0760 (y coordinates of ADC scaling) are positive or negative respectively. However, deadband is active in both directions from point of intersection (x axis with ADC scaling curve), if sign of P0758 and P0760 are opposite.

Fmin (P1080) should be zero when using center zero setup. There is no hysteresis at the end of the deadband.

P0762	Delay for loss of signal action			Min: 0	Level: 3
	CStat: CUT	Datatype: U16	Unit: ms	Def: 10	
	P-Group: TERMINAL	Active: first confirm	QuickComm. No	Max: 10000	

Defines time delay between loss of analog setpoint and appearance of fault code F0080.

Note:

Expert users can choose the desired reaction to F0080 (default is OFF2).

r0770	Number of DACs	Datatype: U16	Unit: -	Min: - Def: - Max: -	Level: 3
	P-Group: TERMINAL				
	Displays number of analog outputs available.				
P0771	CI: DAC	Datatype: U32	Unit: -	Min: 0:0 Def: 21:0 Max: 4000:0	Level: 2
	CStat: CUT	Active: Immediately	QuickComm. No		
	P-Group: TERMINAL				
	Defines function of the 0 - 20 mA analog output.				
	Settings:				
	21 CO: Act. frequency (scaled to P2000)				
	24 CO: Act. output frequency (scaled to P2000)				
	25 CO: Act. output voltage (scaled to P2001)				
	26 CO: Act. DC-link voltage (scaled to P2001)				
	27 CO: Act. output current (scaled to P2002)				
P0773	Smooth time DAC	Datatype: U16	Unit: ms	Min: 0 Def: 2 Max: 1000	Level: 3
	CStat: CUT	Active: Immediately	QuickComm. No		
	P-Group: TERMINAL				
	Defines smoothing time [ms] for analog output signal. This parameter enables smoothing for DAC input using a PT1 filter.				
	Dependency:				
	P0773 = 0: Deactivates filter.				
r0774	Act. DAC value [mA]	Datatype: Float	Unit: -	Min: - Def: - Max: -	Level: 2
	P-Group: TERMINAL				
	Shows value of analog output in [V] or [mA] after filtering and scaling.				
P0776	Type of DAC	Datatype: U16	Unit: -	Min: 0 Def: 0 Max: 0	Level: 4
	CStat: CT	Active: Immediately	QuickComm. No		
	P-Group: TERMINAL				
	Defines type of analog output.				
	Enum:				
	0 Current output				
	Note:				
	The analog output is designed as a current output with a range of 0...20 mA.				
	For a voltage output with a range of 0...10 V an external resistor of 500 Ohms has to be connected at the terminals				
	(12/13).				

P0777	Value x1 of DAC scaling				Min: -99999.0	Level: 2
	CStat: CUT	Datatype: Float	Unit: %	Def: 0.0		
	P-Group: TERMINAL	Active: Immediately	QuickComm. No	Max: 99999.0		

Defines x1 output characteristic in [%]. Scaling block is responsible for adjustment of output value defined in P0771 (DAC connector input).

Parameters of DAC scaling block (P0777 ... P0781) work as follows:

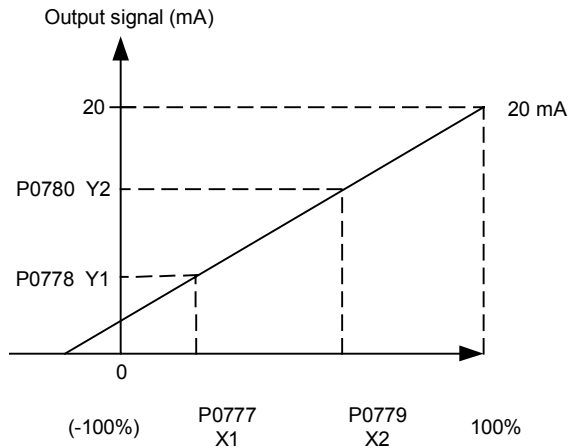

Where:

Points P1 (x1, y1) and P2 (x2, y2) can be chosen freely.

Example:

The default values of the scaling block provides a scaling of P1: 0.0 % = 0 mA or 0 V and P2: 100.0 % = 20 mA or 20 V.

Dependency:

Affects P2000 to P2003 (referency frequency, voltage, current or torque) depending on which setpoint is to be generated.

P0778	Value y1 of DAC scaling				Min: 0	Level: 2
	CStat: CUT	Datatype: Float	Unit: -	Def: 0		
	P-Group: TERMINAL	Active: Immediately	QuickComm. No	Max: 20		

Defines y1 of output characteristic.

P0779	Value x2 of DAC scaling				Min: -99999.0	Level: 2
	CStat: CUT	Datatype: Float	Unit: %	Def: 100.0		
	P-Group: TERMINAL	Active: Immediately	QuickComm. No	Max: 99999.0		

Defines x2 of output characteristic in [%].

Dependency:

Affects P2000 to P2003 (referency frequency, voltage, current or torque) depending on which setpoint is to be generated.

P0780	Value y2 of DAC scaling				Min: 0	Level: 2
	CStat: CUT	Datatype: Float	Unit: -	Def: 20		
	P-Group: TERMINAL	Active: Immediately	QuickComm. No	Max: 20		

Defines y2 of output characteristic.

P0781	Width of DAC deadband				Min: 0	Level: 2
	CStat: CUT	Datatype: Float	Unit: -	Def: 0		
	P-Group: TERMINAL	Active: Immediately	QuickComm. No	Max: 20		

Sets width of dead-band in [mA] for analog output.

P0800	BI: Download parameter set 0	Min: 0:0	Level:
	CStat: CT Datatype: U32 Unit: - Def: 0:0 P-Group: COMMANDS Active: Immediately QuickComm. No Max: 4000:0		3
Defines source of command to start download of parameter set 0 from attached AOP. The first three digits describe the parameter number of the command source, the last digit refers to the bit setting for that parameter.			
Settings:			
722.0 = Digital input 1 (requires P0701 to be set to 99, BICO)			
722.1 = Digital input 2 (requires P0702 to be set to 99, BICO)			
722.2 = Digital input 3 (requires P0703 to be set to 99, BICO)			
Note:			
Signal of digital input: 0 = No download 1 = Start download parameter set 0 from AOP.			
P0801	BI: Download parameter set 1	Min: 0:0	Level:
	CStat: CT Datatype: U32 Unit: - Def: 0:0 P-Group: COMMANDS Active: Immediately QuickComm. No Max: 4000:0		3
Defines sources of command to start download of parameter set 1 from attached AOP. The first three digits describe the parameter number of the command source, the last digit refers to the bit setting for that parameter.			
Settings:			
722.0 = Digital input 1 (requires P0701 to be set to 99, BICO)			
722.1 = Digital input 2 (requires P0702 to be set to 99, BICO)			
722.2 = Digital input 3 (requires P0703 to be set to 99, BICO)			
Note:			
Signal of digital input: 0 = No download 1 = Start download parameter set 1 from AOP.			
P0840	BI: ON/OFF1	Min: 0:0	Level:
	CStat: CT Datatype: U32 Unit: - Def: 722:0 P-Group: COMMANDS Active: Immediately QuickComm. No Max: 4000:0		3
Allows ON/OFF1 command source to be selected using BICO. The first three digits describe the parameter number of the command source; the last digit denotes the bit setting for that parameter.			
Settings:			
722.0 = Digital input 1 (requires P0701 to be set to 99, BICO)			
722.1 = Digital input 2 (requires P0702 to be set to 99, BICO)			
722.2 = Digital input 3 (requires P0703 to be set to 99, BICO)			
722.3 = Digital input 4 (via analog input, requires P0704 to be set to 99)			
19.0 = ON/OFF1 via BOP/AOP			
Dependency:			
Active only when P0719 = 0 (remote selection of command/setpoint source).			
BICO requires P0700 set to 2 (enable BICO).			
The default setting (ON right) is digital input 1 (722.0). Alternative source possible only when function of digital input 1 is changed (via P0701) before changing value of P0840.			
P0842	BI: ON/OFF1 reverse	Min: 0:0	Level:
	CStat: CT Datatype: U32 Unit: - Def: 0:0 P-Group: COMMANDS Active: Immediately QuickComm. No Max: 4000:0		3
Allows ON/OFF1 reverse command source to be selected using BICO. The first three digits describe the parameter number of the command source and the last digit denotes the bit setting for that parameter.			
Settings:			
722.0 = Digital input 1 (requires P0701 to be set to 99, BICO)			
722.1 = Digital input 2 (requires P0702 to be set to 99, BICO)			
722.2 = Digital input 3 (requires P0703 to be set to 99, BICO)			
722.3 = Digital input 4 (via analog input, requires P0704 to be set to 99)			
19.0 = ON/OFF1 via BOP/AOP			
Dependency:			
Active only when P0719 = 0 (remote selection of command/setpoint source).			

P0844	BI: 1. OFF2			Min: 0:0	Level: 3
	CStat: CT	Datatype: U32	Unit: -	Def: 1:0	
	P-Group: COMMANDS	Active: Immediately	QuickComm. No	Max: 4000:0	

Defines first source of OFF2 when P0719 = 0 (BICO). The first three digits describe the parameter number of the command source and the last digit denotes the bit setting for that parameter.

Settings:

722.0 = Digital input 1 (requires P0701 to be set to 99, BICO)
 722.1 = Digital input 2 (requires P0702 to be set to 99, BICO)
 722.2 = Digital input 3 (requires P0703 to be set to 99, BICO)
 722.3 = Digital input 4 (via analog input, requires P0704 to be set to 99)

19.0 = ON/OFF1 via BOP/AOP
 19.1 = OFF2: Electrical stop via BOP/AOP

Dependency:

Active only when P0719 = 0 (remote selection of command/setpoint source).

If one of the digital inputs is selected for OFF2, the inverter will not run unless the digital input is active.

Note:

OFF2 means immediate pulse-disabling; the motor is coasting.

OFF2 is low-active, i.e. :
 0 = Pulse disabling.
 1 = Operating condition.

P0845	BI: 2. OFF2			Min: 0:0	Level: 3
	CStat: CT	Datatype: U32	Unit: -	Def: 19:1	
	P-Group: COMMANDS	Active: Immediately	QuickComm. No	Max: 4000:0	

Defines second source of OFF2. The first three digits describe the parameter number of the command source and the last digit denotes the bit setting for that parameter.

Settings:

722.0 = Digital input 1 (requires P0701 to be set to 99, BICO)
 722.1 = Digital input 2 (requires P0702 to be set to 99, BICO)
 722.2 = Digital input 3 (requires P0703 to be set to 99, BICO)
 722.3 = Digital input 4 (via analog input, requires P0704 to be set to 99)

19.0 = ON/OFF1 via BOP/AOP

Dependency:

In contrast to P0844 (first source of OFF2), this parameter is always active, independent of P0719 (selection of command and frequency setpoint).

If one of the digital inputs is selected for OFF2, the inverter will not run unless the digital input is active.

Note:

OFF2 means immediate pulse-disabling; the motor is coasting.

OFF2 is low-active, i.e. :
 0 = Pulse disabling.
 1 = Operating condition.

P0848	BI: 1. OFF3			Min: 0:0	Level: 3
	CStat: CT	Datatype: U32	Unit: -	Def: 1:0	
	P-Group: COMMANDS	Active: Immediately	QuickComm. No	Max: 4000:0	

Defines first source of OFF3 when P0719 = 0 (BICO). The first three digits describe the parameter number of the command source and the last digit denotes the bit setting for that parameter.

Settings:

722.0 = Digital input 1 (requires P0701 to be set to 99, BICO)
 722.1 = Digital input 2 (requires P0702 to be set to 99, BICO)
 722.2 = Digital input 3 (requires P0703 to be set to 99, BICO)
 722.3 = Digital input 4 (via analog input, requires P0704 to be set to 99)

19.0 = ON/OFF1 via BOP/AOP

Dependency:

Active only when P0719 = 0 (remote selection of command/setpoint source).

If one of the digital inputs is selected for OFF3, the inverter will not run unless the digital input is active.

Note:

OFF3 means fast ramp-down to 0.

OFF3 is low-active, i.e.
 0 = Ramp-down.
 1 = Operating condition.

P0849	BI: 2. OFF3			Min: 0:0	Level: 3
	CStat: CT	Datatype: U32	Unit: -	Def: 1:0	
	P-Group: COMMANDS	Active: Immediately	QuickComm. No	Max: 4000:0	

Defines second source of OFF3. The first three digits describe the parameter number of the command source and the last digit denotes the bit setting for that parameter.

Settings:

722.0 = Digital input 1 (requires P0701 to be set to 99, BICO)
 722.1 = Digital input 2 (requires P0702 to be set to 99, BICO)
 722.2 = Digital input 3 (requires P0703 to be set to 99, BICO)
 722.3 = Digital input 4 (via analog input, requires P0704 to be set to 99)

19.0 = ON/OFF1 via BOP/AOP

Dependency:

In contrast to P0848 (first source of OFF3), this parameter is always active, independent of P0719 (selection of command and frequency setpoint).

If one of the digital inputs is selected for OFF3, the inverter will not run unless the digital input is active.

Note:

OFF3 means fast ramp-down to 0.

OFF3 is low-active, i.e.

0 = Ramp-down.

1 = Operating condition.

P0852	BI: Pulse enable			Min: 0:0	Level: 3
	CStat: CT	Datatype: U32	Unit: -	Def: 1:0	
	P-Group: COMMANDS	Active: Immediately	QuickComm. No	Max: 4000:0	

Defines source of pulse enable/disable signal.

Settings:

722.0 = Digital input 1 (requires P0701 to be set to 99, BICO)
 722.1 = Digital input 2 (requires P0702 to be set to 99, BICO)
 722.2 = Digital input 3 (requires P0703 to be set to 99, BICO)
 722.3 = Digital input 4 (via analog input, requires P0704 to be set to 99)

Dependency:

Active only when P0719 = 0 (remote selection of command/setpoint source).

P0918	CB address			Min: 0	Level: 2
	CStat: CT	Datatype: U16	Unit: -	Def: 3	
	P-Group: COMM	Active: Immediately	QuickComm. No	Max: 65535	

Defines address of CB (communication board) or address of the other option modules.

There are two ways to set the bus address:
 1 via DIP switches on the PROFIBUS module
 2 via a user-entered value

Note:

Possible PROFIBUS settings:

1 ... 125

0, 126, 127 are not allowed

The following applies when a PROFIBUS module is used:

DIP switch = 0 Address defined in P0918 (CB address) is valid

DIP switch not = 0 DIP switch setting has priority and P0918 indicates DIP switch setting.

P0927	Parameter changeable via			Min: 0	Level: 2
	CStat: CUT	Datatype: U16	Unit: -	Def: 15	
	P-Group: COMM	Active: Immediately	QuickComm. No	Max: 15	

Specifies the interfaces which can be used to change parameters.

Example:

"b - - n n" (bits 0, 1, 2 and 3 set) in the default setting means that parameters can be changed via any interface.

"b - - r n" (bits 0, 1 and 3 set) would specify that parameters can be changed via PROFIBUS/CB, BOP and USS on COM link (RS485 USS) but not via USS on BOP link (RS232)

Bitfields:

Bit00	PROFIBUS / CB	0	NO
		1	YES
Bit01	BOP	0	NO
		1	YES
Bit02	USS on BOP link	0	NO
		1	YES
Bit03	USS on COM link	0	NO
		1	YES

Details:

The seven-segment display is explained in the "Introduction to MICROMASTER System Parameters".

r0947[8]	Last fault code	Datatype: U16	Unit: -	Min: -	Level: 2
	P-Group: ALARMS			Def: -	

Displays fault history according to the diagram below

where:

"F1" is the first active fault (not yet acknowledged).

"F2" is the second active fault (not yet acknowledged).

"F1e" is the occurrence of the fault acknowledgement for F1 & F2.

This moves the value in the 2 indices down to the next pair of indices, where they are stored. Indices 0 & 1 contain the active faults. When faults are acknowledged, indices 0 & 1 are reset to 0.

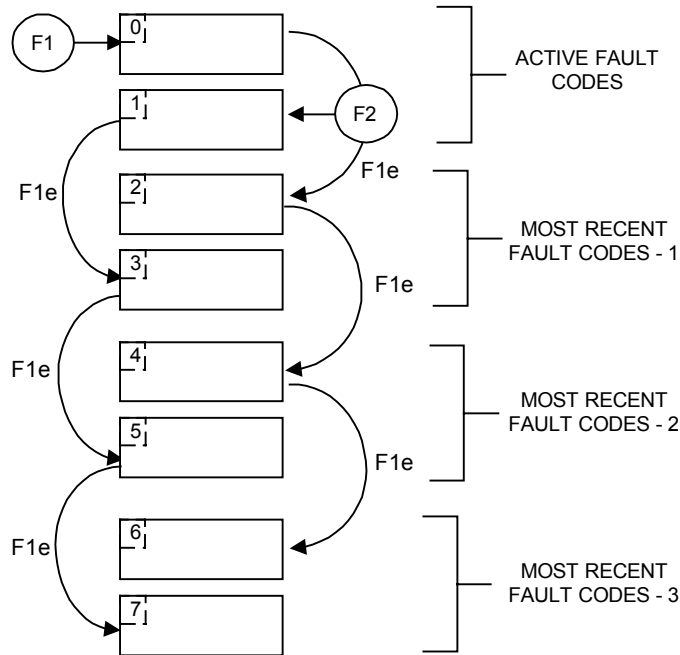

Example:

If the inverter trips on undervoltage and then receives an external trip before the undervoltage is acknowledged, you will obtain:

Index 0 = 3 Undervoltage

Index 1 = 85 External trip

Whenever a fault in index 0 is acknowledged (F1e), the fault history shifts as indicated in the diagram above.

Index:

r0947[0] : Recent fault trip --, fault 1
 r0947[1] : Recent fault trip --, fault 2
 r0947[2] : Recent fault trip -1, fault 3
 r0947[3] : Recent fault trip -1, fault 4
 r0947[4] : Recent fault trip -2, fault 5
 r0947[5] : Recent fault trip -2, fault 6
 r0947[6] : Recent fault trip -3, fault 7
 r0947[7] : Recent fault trip -3, fault 8

Dependency:

Index 2 used only if second fault occurs before first fault is acknowledged.

Details:

See fault codes in Operating Instructions Manual.

r0948[12]	Fault time	Datatype: U16	Unit: -	Min: -	Level: 3
	P-Group: ALARMS			Def: - Max: -	

Time stamp to indicate when the fault has occurred. P2114 (run-time counter) or P2115 (real time clock) are the possible sources of the time stamp.

Example:

The time is taken from P2115 if this parameter has been updated with the real time. If not, P2114 is used.

Index:

- r0948[0] : Recent fault trip --, fault time seconds+minutes
- r0948[1] : Recent fault trip --, fault time hours+days
- r0948[2] : Recent fault trip --, fault time month+year
- r0948[3] : Recent fault trip -1, fault time seconds+minutes
- r0948[4] : Recent fault trip -1, fault time hours+days
- r0948[5] : Recent fault trip -1, fault time month+year
- r0948[6] : Recent fault trip -2, fault time seconds+minutes
- r0948[7] : Recent fault trip -2, fault time hours+days
- r0948[8] : Recent fault trip -2, fault time month+year
- r0948[9] : Recent fault trip -3, fault time seconds+minutes
- r0948[10] : Recent fault trip -3, fault time hours+days
- r0948[11] : Recent fault trip -3, fault time month+year

Note:

P2115 can be updated via AOP, Starter, DriveMonitor, etc.

r0949[8]	Fault value	Datatype: U16	Unit: -	Min: -	Level: 4
	P-Group: ALARMS			Def: - Max: -	

Displays drive fault values.

Index:

- r0949[0] : Recent fault trip --, fault value 1
- r0949[1] : Recent fault trip --, fault value 2
- r0949[2] : Recent fault trip -1, fault value 3
- r0949[3] : Recent fault trip -1, fault value 4
- r0949[4] : Recent fault trip -2, fault value 5
- r0949[5] : Recent fault trip -2, fault value 6
- r0949[6] : Recent fault trip -3, fault value 7
- r0949[7] : Recent fault trip -3, fault value 8

P0952	Total number of faults			Min: 0	Level: 3
	CStat: CT	Datatype: U16	Unit: -	Def: 0	
	P-Group: ALARMS	Active: Immediately	QuickComm. No	Max: 8	

Displays number of faults stored in P0947 (last fault code).

Dependency:

Setting 0 resets fault history (changing to 0 also resets parameter P0948 - fault time).

r0964[5]	Firmware version data	Datatype: U16	Unit: -	Min: -	Level: 3
	P-Group: COMM			Def: - Max: -	

Firmware version data.

Example:

- r0964[0] = 42 "SIEMENS"
- r0964[1] = 1001 "MICROMASTER 420"
- 1002 "MICROMASTER 440"
- 1003 "MICRO- / COMBIMASTER 411"
- 1004 "MICROMASTER 410"
- 1005 "Reserved"
- r0964[4] = 507 means 5th July.

Index:

- r0964[0] : Company (Siemens = 42)
- r0964[1] : Product type
- r0964[2] : Firmware version
- r0964[3] : Firmware date (year)
- r0964[4] : Firmware date (day/month)

r0965	Profibus profile	Datatype: U16	Unit: -	Min: -	Level: 3
	P-Group: COMM			Def: - Max: -	

Identification for PROFIDrive. Profile number and version.

r0967	Control word 1	Datatype: U16	Unit: -	Min: - Def: - Max: -	Level: 3
	P-Group: COMM				
	Displays control word 1.				
	Bitfields:				
	Bit00	ON/OFF1	0	NO	
			1	YES	
	Bit01	OFF2: Electrical stop	0	YES	
			1	NO	
	Bit02	OFF3: Fast stop	0	YES	
			1	NO	
	Bit03	Pulse enable	0	NO	
			1	YES	
	Bit04	RFG enable	0	NO	
			1	YES	
	Bit05	RFG start	0	NO	
			1	YES	
	Bit06	Setpoint enable	0	NO	
			1	YES	
	Bit07	Fault acknowledge	0	NO	
			1	YES	
	Bit08	JOG right	0	NO	
			1	YES	
	Bit09	JOG left	0	NO	
			1	YES	
	Bit10	Control from PLC	0	NO	
			1	YES	
	Bit11	Reverse (setpoint inversion)	0	NO	
			1	YES	
	Bit13	Motor potentiometer MOP up	0	NO	
			1	YES	
	Bit14	Motor potentiometer MOP down	0	NO	
			1	YES	
	Bit15	Local / Remote	0	NO	
			1	YES	
r0968	Status word 1	Datatype: U16	Unit: -	Min: - Def: - Max: -	Level: 3
	P-Group: COMM				
	Displays active status word of inverter (in binary) and can be used to diagnose which commands are active.				
	Bitfields:				
	Bit00	Drive ready	0	NO	
			1	YES	
	Bit01	Drive ready to run	0	NO	
			1	YES	
	Bit02	Drive running	0	NO	
			1	YES	
	Bit03	Drive fault active	0	NO	
			1	YES	
	Bit04	OFF2 active	0	YES	
			1	NO	
	Bit05	OFF3 active	0	YES	
			1	NO	
	Bit06	ON inhibit active	0	NO	
			1	YES	
	Bit07	Drive warning active	0	NO	
			1	YES	
	Bit08	Deviation setp. / act. value	0	YES	
			1	NO	
	Bit09	PZD control	0	NO	
			1	YES	
	Bit10	Maximum frequency reached	0	NO	
			1	YES	
	Bit11	Warning: Motor current limit	0	YES	
			1	NO	
	Bit12	Motor holding brake active	0	NO	
			1	YES	
	Bit13	Motor overload	0	YES	
			1	NO	
	Bit14	Motor runs direction right	0	NO	
			1	YES	
	Bit15	Inverter overload	0	YES	
			1	NO	

P0970	Factory reset	Datatype: U16	Unit: -	Min: 0	Level: 1
	CStat: C	Active: Immediately	QuickComm. No	Def: 0	
	P-Group: PAR_RESET			Max: 1	

P0970 = 1 resets all parameters to their default values.

Enum:

- 0 Disabled
- 1 Parameter reset

Dependency:

First set P0010 = 30 (factory settings)

Stop drive (i.e. disable all pulses) before you can reset parameters to default values.

Note:

The following parameters retain their values after a factory reset:
 P0918 (CB address),
 P2010 (USS baud rate) and
 P2011 (USS address)

P0971	Transfer data from RAM to EEPROM	Datatype: U16	Unit: -	Min: 0	Level: 3
	CStat: CUT	Active: Immediately	QuickComm. No	Def: 0	
	P-Group: COMM			Max: 1	

Transfers values from RAM to EEPROM when set to 1.

Enum:

- 0 Disabled
- 1 Start transfer

Note:

All values in RAM are transferred to EEPROM.

Parameter is automatically reset to 0 (default) after successful transfer.

P1000	Selection of frequency setpoint				Min: 0	Level: 1
	CStat: CT	Datatype: U16	Unit: -	Def: 2		
	P-Group: SETPOINT	Active: Immediately	QuickComm: Yes	Max: 66		

Selects frequency setpoint source. In the table of possible settings below, the main setpoint is selected from the least significant digit (i.e., 0 to 6) and any additional setpoint from the most significant digit (i.e., x0 through to x6).

Example:

Setting 12 selects main setpoint (2) derived from analog input with additional setpoint (1) taken from the motor potentiometer.

Settings:

- 1 Motor potentiometer setpoint
- 2 Analog input
- 3 Fixed frequency setpoint
- 4 USS on BOP link
- 5 USS on COM link
- 6 Communication board (CB) on COM link

Other settings including an additional setpoint can be selected using the table above.

Enum:

- | | |
|----|------------------------------------|
| 0 | No main setpoint |
| 1 | MOP setpoint |
| 2 | Analog setpoint |
| 3 | Fixed frequency |
| 4 | USS on BOP link |
| 5 | USS on COM link |
| 6 | CB on COM link |
| 10 | No main setpoint + MOP setpoint |
| 11 | MOP setpoint + MOP setpoint |
| 12 | Analog setpoint + MOP setpoint |
| 13 | Fixed frequency + MOP setpoint |
| 14 | USS on BOP link + MOP setpoint |
| 15 | USS on COM link + MOP setpoint |
| 16 | CB on COM link + MOP setpoint |
| 20 | No main setpoint + Analog setpoint |
| 21 | MOP setpoint + Analog setpoint |
| 22 | Analog setpoint + Analog setpoint |
| 23 | Fixed frequency + Analog setpoint |
| 24 | USS on BOP link + Analog setpoint |
| 25 | USS on COM link + Analog setpoint |
| 26 | CB on COM link + Analog setpoint |
| 30 | No main setpoint + Fixed frequency |
| 31 | MOP setpoint + Fixed frequency |
| 32 | Analog setpoint + Fixed frequency |
| 33 | Fixed frequency + Fixed frequency |
| 34 | USS on BOP link + Fixed frequency |
| 35 | USS on COM link + Fixed frequency |
| 36 | CB on COM link + Fixed frequency |
| 40 | No main setpoint + USS on BOP link |
| 41 | MOP setpoint + USS on BOP link |
| 42 | Analog setpoint + USS on BOP link |
| 43 | Fixed frequency + USS on BOP link |
| 44 | USS on BOP link + USS on BOP link |
| 45 | USS on COM link + USS on BOP link |
| 46 | CB on COM link + USS on BOP link |
| 50 | No main setpoint + USS on COM link |
| 51 | MOP setpoint + USS on COM link |
| 52 | Analog setpoint + USS on COM link |
| 53 | Fixed frequency + USS on COM link |
| 54 | USS on BOP link + USS on COM link |
| 55 | USS on COM link + USS on COM link |
| 56 | CB on COM link + USS on COM link |
| 60 | No main setpoint + CB on COM link |
| 61 | MOP setpoint + CB on COM link |
| 62 | Analog setpoint + CB on COM link |
| 63 | Fixed frequency + CB on COM link |
| 64 | USS on BOP link + CB on COM link |
| 65 | USS on COM link + CB on COM link |
| 66 | CB on COM link + CB on COM link |

Note:

Single digits denote main setpoints that have no additional setpoint.

P1001	Fixed frequency 1	Datatype: Float	Unit: Hz	Min: -650.00	Level: 2
	CStat: CUT	Active: first confirm	QuickComm. No	Def: 0.00	
	P-Group: SETPOINT			Max: 650.00	

Defines fixed frequency setpoint 1.

There are 3 types of fixed frequencies:

1. Direct selection
2. Direct selection + ON command
3. Binary coded selection + ON command

1. Direct selection (P0701 - P0703 = 15)

In this mode of operation 1 digital input selects 1 fixed frequency.
If several inputs are active together, the selected frequencies are summed.
E.g.: FF1 + FF2 + FF3.

2. Direct selection + ON command (P0701 - P0703 = 16)

The fixed frequency selection combines the fixed frequencies with an ON command.
In this mode of operation 1 digital input selects 1 fixed frequency.
If several inputs are active together, the selected frequencies are summed.
E.g.: FF1 + FF2 + FF3.

3. Binary coded selection + ON command (P0701 - P0703 = 17)

Up to 7 fixed frequencies can be selected using this method. The fixed frequencies are selected according to the following table:

		DIN3	DIN2	DIN1
	OFF	Inactive	Inactive	Inactive
P1001	FF1	Inactive	Inactive	Active
P1002	FF2	Inactive	Active	Inactive
P1003	FF3	Inactive	Active	Active
P1004	FF4	Active	Inactive	Inactive
P1005	FF5	Active	Inactive	Active
P1006	FF6	Active	Active	Inactive
P1007	FF7	Active	Active	Active

Dependency:

Select fixed frequency operation (using P1000).

Inverter requires ON command to start in the case of direct selection (P0701 - P0706 = 15)

Note:

Fixed frequencies can be selected using the digital inputs, and can also be combined with an ON command.

P1002	Fixed frequency 2	Datatype: Float	Unit: Hz	Min: -650.00	Level: 2
	CStat: CUT	Active: first confirm	QuickComm. No	Def: 5.00	
	P-Group: SETPOINT			Max: 650.00	

Defines fixed frequency setpoint 2.

Details:

See parameter P1001 (fixed frequency 1).

P1003	Fixed frequency 3	Datatype: Float	Unit: Hz	Min: -650.00	Level: 2
	CStat: CUT	Active: first confirm	QuickComm. No	Def: 10.00	
	P-Group: SETPOINT			Max: 650.00	

Defines fixed frequency setpoint 3.

Details:

See parameter P1001 (fixed frequency 1).

P1004	Fixed frequency 4	Datatype: Float	Unit: Hz	Min: -650.00	Level: 2
	CStat: CUT	Active: first confirm	QuickComm. No	Def: 15.00	
	P-Group: SETPOINT			Max: 650.00	

Defines fixed frequency setpoint 4.

Details:

See parameter P1001 (fixed frequency 1).

P1005	Fixed frequency 5	Datatype: Float	Unit: Hz	Min: -650.00	Level: 2
	CStat: CUT	Active: first confirm	QuickComm. No	Def: 20.00	
	P-Group: SETPOINT			Max: 650.00	

Defines fixed frequency setpoint 5.

Details:

See parameter P1001 (fixed frequency 1).

P1006	Fixed frequency 6 CStat: CUT Datatype: Float Unit: Hz Min: -650.00 P-Group: SETPOINT Active: first confirm QuickComm. No Def: 25.00 Max: 650.00	Level: 2
Defines fixed frequency setpoint 6. Details: See parameter P1001 (fixed frequency 1).		
P1007	Fixed frequency 7 CStat: CUT Datatype: Float Unit: Hz Min: -650.00 P-Group: SETPOINT Active: first confirm QuickComm. No Def: 30.00 Max: 650.00	Level: 2
Defines fixed frequency setpoint 7. Details: See parameter P1001 (fixed frequency 1).		
P1016	Fixed frequency mode - Bit 0 CStat: CT Datatype: U16 Unit: - Min: 1 P-Group: SETPOINT Active: Immediately QuickComm. No Def: 1 Max: 3	Level: 3
Fixed frequencies can be selected in three different modes. Parameter P1016 defines the mode of selection Bit 0. Enum: 1 Direct selection 2 Direct selection + ON command 3 Binary coded selection + ON command Details: See table in P1001 (fixed frequency 1) for description of how to use fixed frequencies.		
P1017	Fixed frequency mode - Bit 1 CStat: CT Datatype: U16 Unit: - Min: 1 P-Group: SETPOINT Active: Immediately QuickComm. No Def: 1 Max: 3	Level: 3
Fixed frequencies can be selected in three different modes. Parameter P1017 defines the mode of selection Bit 1. Enum: 1 Direct selection 2 Direct selection + ON command 3 Binary coded selection + ON command Details: See table in P1001 (fixed frequency 1) for description of how to use fixed frequencies.		
P1018	Fixed frequency mode - Bit 2 CStat: CT Datatype: U16 Unit: - Min: 1 P-Group: SETPOINT Active: Immediately QuickComm. No Def: 1 Max: 3	Level: 3
Fixed frequencies can be selected in three different modes. Parameter P1018 defines the mode of selection Bit 2. Enum: 1 Direct selection 2 Direct selection + ON command 3 Binary coded selection + ON command Details: See table in P1001 (fixed frequency 1) for description of how to use fixed frequencies.		
P1020	BI: Fixed freq. selection Bit 0 CStat: CT Datatype: U32 Unit: - Min: 0:0 P-Group: COMMANDS Active: Immediately QuickComm. No Def: 0:0 Max: 4000:0	Level: 3
Defines origin of fixed frequency selection. Settings: P1020 = 722.0 ==> Digital input 1 P1021 = 722.1 ==> Digital input 2 P1022 = 722.2 ==> Digital input 3 Dependency: Accessible only if P0701 - P0703 = 99 (function of digital inputs = BICO)		
P1021	BI: Fixed freq. selection Bit 1 CStat: CT Datatype: U32 Unit: - Min: 0:0 P-Group: COMMANDS Active: Immediately QuickComm. No Def: 0:0 Max: 4000:0	Level: 3
Defines origin of fixed frequency selection. Dependency: Accessible only if P0701 - P0703 = 99 (function of digital inputs = BICO) Details: See P1020 (fixed frequency selection Bit 0) for most common settings		

P1022	BI: Fixed freq. selection Bit 2 CStat: CT Datatype: U32 Unit: - Min: 0:0 P-Group: COMMANDS Active: Immediately QuickComm. No Def: 0:0 Max: 4000:0	Level: 3
	Defines origin of fixed frequency selection.	
	Dependency: Accessible only if P0701 - P0703 = 99 (function of digital inputs = BICO)	
	Details: See P1020 (fixed frequency selection Bit 0) for most common settings	
r1024	CO: Act. fixed frequency Datatype: Float Unit: Hz Min: - P-Group: SETPOINT Active: - QuickComm. No Def: - Max: -	Level: 3
	Displays sum total of selected fixed frequencies.	
P1031	Setpoint memory of the MOP CStat: CUT Datatype: U16 Unit: - Min: 0 P-Group: SETPOINT Active: first confirm QuickComm. No Def: 0 Max: 1	Level: 2
	Saves last motor potentiometer setpoint (MOP) that was active before OFF command or power down.	
	Enum: 0 PID-MOP setpoint will not be stored 1 PID-MOP setpoint will be stored (P2240 is updated)	
	Note: On next ON command, motor potentiometer setpoint will be the saved value in parameter P1040 (setpoint of the MOP).	
P1032	Inhibit reverse direction of MOP CStat: CT Datatype: U16 Unit: - Min: 0 P-Group: SETPOINT Active: Immediately QuickComm. No Def: 1 Max: 1	Level: 2
	Inhibits reverse setpoint selection	
	Enum: 0 Reserve direction is allowed 1 Reserve direction inhibited	
	Dependency: Motor potentiometer (P1040) must be chosen as main setpoint or additional setpoint (using P1000).	
	Note: It is possible to change motor direction using the motor potentiometer setpoint (increase / decrease frequency either by using digital inputs or BOP/AOP keypad up / down).	
P1035	BI: Enable MOP (UP-command) CStat: CT Datatype: U32 Unit: - Min: 0:0 P-Group: COMMANDS Active: Immediately QuickComm. No Def: 19:13 Max: 4000:0	Level: 3
	Defines source for motor potentiometer setpoint increase frequency.	
	Settings: 722.0 = Digital input 1 (requires P0701 to be set to 99, BICO) 722.1 = Digital input 2 (requires P0702 to be set to 99, BICO) 722.2 = Digital input 3 (requires P0703 to be set to 99, BICO) 722.3 = Digital input 4 (via analog input, requires P0704 to be set to 99) 19.D = MOP up via BOP/AOP	
P1036	BI: Enable MOP (DOWN-command) CStat: CT Datatype: U32 Unit: - Min: 0:0 P-Group: COMMANDS Active: Immediately QuickComm. No Def: 19:14 Max: 4000:0	Level: 3
	Defines source for motor potentiometer setpoint decrease frequency.	
	Settings: 722.0 = Digital input 1 (requires P0701 to be set to 99, BICO) 722.1 = Digital input 2 (requires P0702 to be set to 99, BICO) 722.2 = Digital input 3 (requires P0703 to be set to 99, BICO) 722.3 = Digital input 4 (via analog input, requires P0704 to be set to 99) 19.E = MOP down via BOP/AOP	
P1040	Setpoint of the MOP CStat: CUT Datatype: Float Unit: Hz Min: -650.00 P-Group: SETPOINT Active: first confirm QuickComm. No Def: 5.00 Max: 650.00	Level: 2
	Determines setpoint for motor potentiometer control (P1000 = 1).	
	Note: If motor potentiometer setpoint is selected either as main setpoint or additional setpoint, the reverse direction will be inhibited by default of P1032 (inhibit reverse direction of MOP). To re-enable reverse direction, set P1032 = 0.	

r1050	CO: Act. Output freq. of the MOP	Datatype: Float	Unit: Hz	Min: -	Def: -	Level:
	P-Group: SETPOINT			Max: -		3

Displays output frequency of motor potentiometer setpoint ([Hz]).

P1055	BI: Enable JOG right	Datatype: U32	Unit: -	Min: 0:0	Def: 0:0	Level:
	P-Group: COMMANDS	Active: Immediately	QuickComm. No	Max: 4000:0		3

Defines source of JOG right when P0719 = 0 (remote selection of command/setpoint source).

Settings:

- 722.0 = Digital input 1 (requires P0701 to be set to 99, BICO)
- 722.1 = Digital input 2 (requires P0702 to be set to 99, BICO)
- 722.2 = Digital input 3 (requires P0703 to be set to 99, BICO)
- 722.3 = Digital input 4 (via analog input, requires P0704 to be set to 99)

19.8 = JOG right via BOP/AOP

P1056	BI: Enable JOG left	Datatype: U32	Unit: -	Min: 0:0	Def: 0:0	Level:
	P-Group: COMMANDS	Active: Immediately	QuickComm. No	Max: 4000:0		3

Defines source of JOG left when P0719 = 0 (remote selection of command/setpoint source).

Settings:

- 722.0 = Digital input 1 (requires P0701 to be set to 99, BICO)
- 722.1 = Digital input 2 (requires P0702 to be set to 99, BICO)
- 722.2 = Digital input 3 (requires P0703 to be set to 99, BICO)
- 722.3 = Digital input 4 (via analog input, requires P0704 to be set to 99)

19.9 = JOG left via BOP/AOP

P1058	JOG frequency right	Datatype: Float	Unit: Hz	Min: 0.00	Def: 5.00	Level:
	P-Group: SETPOINT	Active: first confirm	QuickComm. No	Max: 650.00		2

Jogging advances the motor speed by small amounts. The JOG buttons uses a non-latching switch on one of the digital inputs to control the motor speed.

While JOG right is selected, this parameter determines the frequency at which the inverter will run.

Dependency:

P1060 and P1061 set up and down ramp times respectively for jogging.

P1059	JOG frequency left	Datatype: Float	Unit: Hz	Min: 0.00	Def: 5.00	Level:
	P-Group: SETPOINT	Active: first confirm	QuickComm. No	Max: 650.00		2

While JOG left is selected, this parameter determines the frequency at which the inverter will run.

Dependency:

P1060 and P1061 set up and down ramp times respectively for jogging.

P1060	JOG ramp-up time	Datatype: Float	Unit: s	Min: 0.00	Def: 10.00	Level:
	P-Group: SETPOINT	Active: Immediately	QuickComm. No	Max: 650.00		2

Sets ramp-up time. This is the time used while jogging or when P1124 (enable JOG ramp times) is active.

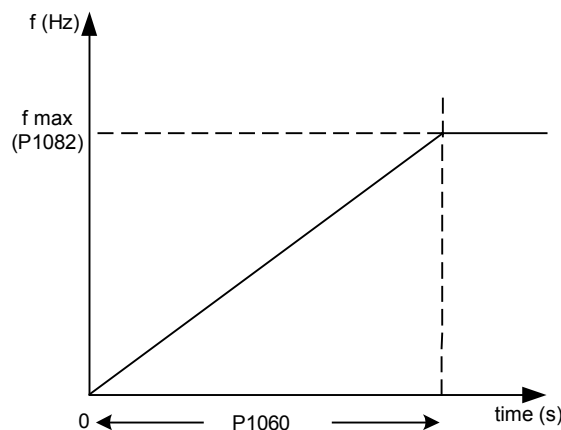

P1061	JOG ramp-down time	Min: 0.00	Level: 2	
	CStat: CUT	Datatype: Float		Unit: s
	P-Group: SETPOINT	Active: Immediately		QuickComm. No Def: 10.00 Max: 650.00

Sets ramp-down time. This is the time used while jogging or when P1124 (enable JOG ramp times) is active.

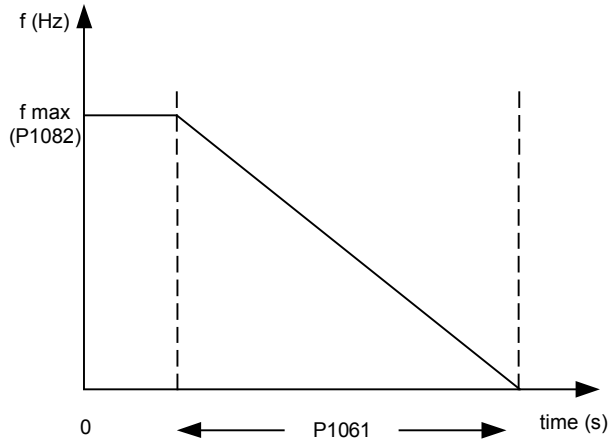

P1070	CI: Main setpoint	Min: 0.00	Level: 3	
	CStat: CT	Datatype: U32		Unit: -
	P-Group: SETPOINT	Active: Immediately		QuickComm. No Def: 755:0 Max: 4000:0

Defines source of main setpoint.

Settings:

- 755 = Analog input 1 setpoint
- 1024 = Fixed frequency setpoint
- 1050 = Motor potentiometer (MOP) setpoint

P1071	CI: Main setpoint scaling	Min: 0:0	Level: 3	
	CStat: CT	Datatype: U32		Unit: -
	P-Group: SETPOINT	Active: Immediately		QuickComm. No Def: 1:0 Max: 4000:0

Defines source of the main setpoint scaling.

Settings:

- 755 = Analog input 1 setpoint
- 1024 = Fixed frequency setpoint
- 1050 = Motor potentiometer (MOP) setpoint

P1074	BI: Disable additional setpoint	Min: 0:0	Level: 3	
	CStat: CUT	Datatype: U32		Unit: -
	P-Group: COMMANDS	Active: Immediately		QuickComm. No Def: 0:0 Max: 4000:0

Disables additional setpoint

Settings:

- 722.0 = Digital input 1 (requires P0701 to be set to 99, BICO)
- 722.1 = Digital input 2 (requires P0702 to be set to 99, BICO)
- 722.2 = Digital input 3 (requires P0703 to be set to 99, BICO)
- 722.3 = Digital input 4 (via analog input, requires P0704 to be set to 99)

P1075	CI: Additional setpoint	Min: 0:0	Level: 3	
	CStat: CT	Datatype: U32		Unit: -
	P-Group: SETPOINT	Active: Immediately		QuickComm. No Def: 0:0 Max: 4000:0

Defines source of the additional setpoint (to be added to main setpoint).

Settings:

- 755 = Analog input 1 setpoint
- 1024 = Fixed frequency setpoint
- 1050 = Motor potentiometer (MOP) setpoint

P1076	CI: Additional setpoint scaling	Min: 0:0	Level: 3	
	CStat: CT	Datatype: U32		Unit: -
	P-Group: SETPOINT	Active: Immediately		QuickComm. No Def: 1:0 Max: 4000:0

Defines source of scaling for additional setpoint (to be added to main setpoint).

Settings:

- 1 = Scaling of 1.0 (100%)
- 755 = Analog input 1 Setpoint
- 1024 = Fixed Frequency Setpoint
- 1050 = MOP Setpoint

r1078	CO: Total frequency setpoint	Datatype: Float	Unit: Hz	Min: - Def: - Max: -	Level: 3
	P-Group: SETPOINT				
Displays sum of main and additional setpoints in [Hz].					
r1079	CO: Selected frequency setpoint	Datatype: Float	Unit: Hz	Min: - Def: - Max: -	Level: 3
	P-Group: SETPOINT				
Displays selected frequency setpoint.					
Following frequency setpoints are displayed: Total frequency setpoint r1078 JOG frequency right P1058 JOG frequency left P1059					
Dependency: P1055 (BI: Enable JOG right) or P1056 (BI: Enable JOG left) define command source of JOG right or JOG left respectively.					
Note: P1055 = 0 and P1056 = 0 ==> Total frequency setpoint is selected.					
P1080	Min. frequency	Datatype: Float	Unit: Hz	Min: 0.00 Def: 0.00 Max: 650.00	Level: 1
	CStat: CUT P-Group: SETPOINT	Active: first confirm	QuickComm. Yes		
Sets minimum motor frequency [Hz] at which motor will run irrespective of frequency setpoint.					
Note: Value set here is valid both for clockwise and for anticlockwise rotation. Under certain conditions (e.g. ramping, current limiting), motor can run below minimum frequency.					
P1082	Max. frequency	Datatype: Float	Unit: Hz	Min: 0.00 Def: 50.00 Max: 650.00	Level: 1
	CStat: CT P-Group: SETPOINT	Active: Immediately	QuickComm. Yes		
Sets maximum motor frequency [Hz] at which motor will run irrespective of the frequency setpoint.					
Note: The value set here is valid for both clockwise and anticlockwise rotation. The maximum output frequency of inverter can be exceeded if one of the following is active: Slip compensation = $f_{max} + f_{slipcomp\ max}$ or Flying restart = $f_{max} + f_{slipnom}$					
Notice: Maximum motor speed is subject to mechanical limitations.					

P1091	Skip frequency 1	Datatype: Float	Unit: Hz	Min: 0.00	Level: 3
	CStat: CUT	Active: first confirm	QuickComm. No	Def: 0.00	
	P-Group: SETPOINT			Max: 650.00	

Defines skip frequency 1 which avoids effects of mechanical resonance and suppresses frequencies within +/- P1101 (skip frequency bandwidth).

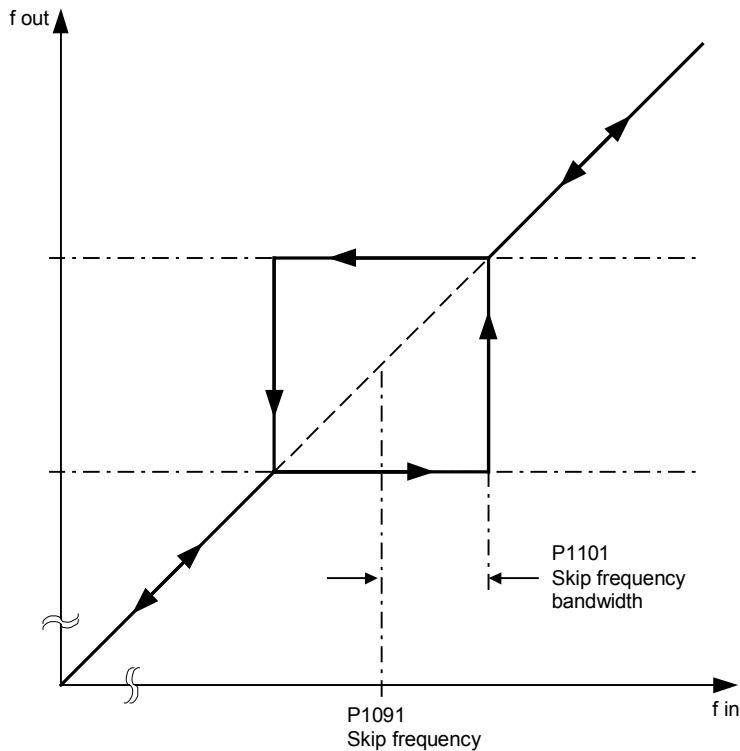

Notice: Stationary operation is not possible within the suppressed frequency range; the range is merely passed through (on the ramp).

For example, if P1091 = 10 Hz and P1101 = 2 Hz, it is not possible to operate continuously between 10 Hz +/- 2 Hz (i.e. between 8 and 12 Hz).

P1092	Skip frequency 2	Datatype: Float	Unit: Hz	Min: 0.00	Level: 3
	CStat: CUT	Active: first confirm	QuickComm. No	Def: 0.00	
	P-Group: SETPOINT			Max: 650.00	

Defines skip frequency 2 which avoids effects of mechanical resonance and suppresses frequencies within +/- P1101 (skip frequency bandwidth).

Details:
See P1091 (skip frequency 1).

P1093	Skip frequency 3	Datatype: Float	Unit: Hz	Min: 0.00	Level: 3
	CStat: CUT	Active: first confirm	QuickComm. No	Def: 0.00	
	P-Group: SETPOINT			Max: 650.00	

Defines skip frequency 3 which avoids effects of mechanical resonance and suppresses frequencies within +/- P1101 (skip frequency bandwidth).

Details:
See P1091 (skip frequency 1).

P1094	Skip frequency 4	Datatype: Float	Unit: Hz	Min: 0.00	Level: 3
	CStat: CUT	Active: first confirm	QuickComm. No	Def: 0.00	
	P-Group: SETPOINT			Max: 650.00	

Defines skip frequency 4 which avoids effects of mechanical resonance and suppresses frequencies within +/- P1101 (skip frequency bandwidth).

Details:
See P1091 (skip frequency 1).

P1101	Skip frequency bandwidth	Min: 0.00	Level:
	CStat: CUT Datatype: Float Unit: Hz Def: 2.00 P-Group: SETPOINT Active: first confirm QuickComm. No Max: 10.00		3
Delivers frequency bandwidth to be applied to skip frequencies (in [Hz]).			
Details: See P1091 (skip frequency 1).			
P1110	BI: Inhibit neg. freq. setpoint	Min: 0:0	Level:
	CStat: CT Datatype: U32 Unit: - Def: 0:0 P-Group: COMMANDS Active: Immediately QuickComm. No Max: 4000:0		3
Inhibits direction reversal, thus preventing a negative setpoint from causing motor from running in reverse. Instead, it will run at minimum frequency (P1080) in the normal direction.			
Settings: 0 = Disabled 1 = Enabled			
Note: It is possible to disable all reverse commands (i.e. the command is ignored). To do this, set P0719 = 0 (remote selection of command/setpoint source) and define the command sources (P1113) individually.			
Notice: This function does not disable the "reverse" command function; rather, a reverse command causes motor to run in the normal direction as described above.			
P1113	BI: Reverse	Min: 0:0	Level:
	CStat: CT Datatype: U32 Unit: - Def: 722:1 P-Group: COMMANDS Active: Immediately QuickComm. No Max: 4000:0		3
Defines source of reverse command used when P0719 = 0 (remote selection of command/setpoint source).			
Settings: 722.0 = Digital input 1 (requires P0701 to be set to 99, BICO) 722.1 = Digital input 2 (requires P0702 to be set to 99, BICO) 722.2 = Digital input 3 (requires P0703 to be set to 99, BICO) 19.B = Reverse via BOP/AOP			
r1114	CO: Freq. setp. after dir. ctrl.	Min: -	Level:
	Datatype: Float Unit: Hz Def: - P-Group: SETPOINT Max: -		3
Displays setpoint frequency after change of direction			
r1119	CO: Freq. setpoint before RFG	Min: -	Level:
	Datatype: Float Unit: Hz Def: - P-Group: SETPOINT Max: -		3
Displays output frequency after modification by other functions, e.g. BI: Inhibit neg. freq. setpoint (P1110) or skip frequencies, f_min, f_max, limitations, etc.			

P1120	Ramp-up time	Datatype: Float	Unit: s	Min: 0.00	Level: 1
	CStat: CUT	Active: Immediately	QuickComm: Yes	Def: 10.00	
	P-Group: SETPOINT			Max: 650.00	

Time taken for motor to accelerate from standstill up to maximum motor frequency (P1082) when no rounding is used.

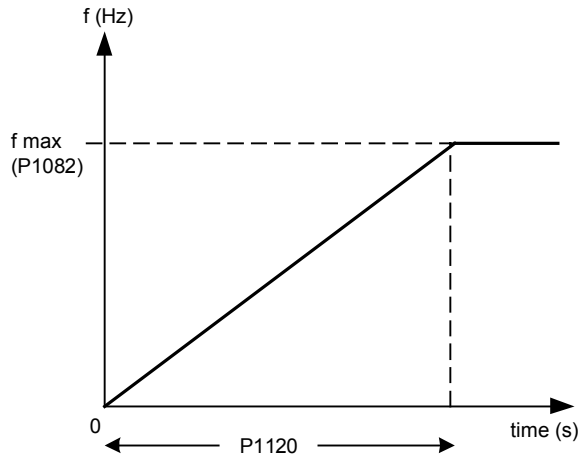

Setting the ramp-up time too short can cause the inverter to trip (overcurrent).

Note:

If an external frequency setpoint with set ramp rates is used (e.g. from a PLC), the best way to achieve optimum drive performance is to set ramp times in P1120 and P1121 slightly shorter than those of the PLC.

P1121	Ramp-down time	Datatype: Float	Unit: s	Min: 0.00	Level: 1
	CStat: CUT	Active: Immediately	QuickComm: Yes	Def: 10.00	
	P-Group: SETPOINT			Max: 650.00	

Time taken for motor to decelerate from maximum motor frequency (P1082) down to standstill when no rounding is used.

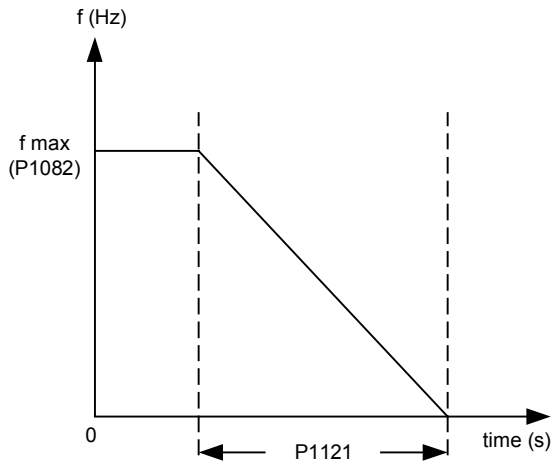

Notice:

Setting the ramp-down time too short can cause the inverter to trip (overcurrent (F0001) / overvoltage (F0002)).

P1124	BI: Enable JOG ramp times	Datatype: U32	Unit: -	Min: 0:0	Level: 3
	CStat: CT	Active: Immediately	QuickComm: No	Def: 0:0	
	P-Group: COMMANDS			Max: 4000:0	

Defines source for switching between jog ramp times and normal ramp times as applied to the RFG.

Settings:

- 722.0 = Digital input 1 (requires P0701 to be set to 99, BICO)
- 722.1 = Digital input 2 (requires P0702 to be set to 99, BICO)
- 722.2 = Digital input 3 (requires P0703 to be set to 99, BICO)

P1130	Ramp-up initial rounding time			Min: 0.00	Level: 2
	CStat: CUT	Datatype: Float	Unit: s	Def: 0.00	
	P-Group: SETPOINT	Active: Immediately	QuickComm. No	Max: 40.00	

Defines initial rounding time in seconds as shown on the diagram below.

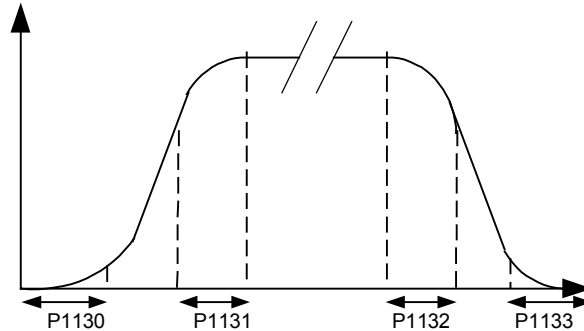

where:

$$T_{up\ total} = \frac{1}{2}P1130 + X * P1120 + \frac{1}{2}P1131$$

$$T_{down\ total} = \frac{1}{2}P1130 + X * P1121 + \frac{1}{2}P1133$$

X is defined as $\Delta f = X * f_{max}$

i.e. X is the ratio between the frequency step and f_{max}

Note:

Rounding times are recommended, since they prevent an abrupt response, thus avoiding detrimental effects on the mechanics.

Notice:

Rounding times are not recommended when analog inputs are used, since they would result in overshoot/undershoot in the inverter response.

P1131	Ramp-up final rounding time			Min: 0.00	Level: 2
	CStat: CUT	Datatype: Float	Unit: s	Def: 0.00	
	P-Group: SETPOINT	Active: Immediately	QuickComm. No	Max: 40.00	

Defines rounding time at end of ramp-up as shown in P1130 (ramp-up initial rounding time).

Note:

Rounding times are recommended, since they prevent an abrupt response, thus avoiding detrimental effects on the mechanics.

Notice:

Rounding times are not recommended when analog inputs are used, since they would result in overshoot/undershoot in the inverter response.

P1132	Ramp-down initial rounding time			Min: 0.00	Level: 2
	CStat: CUT	Datatype: Float	Unit: s	Def: 0.00	
	P-Group: SETPOINT	Active: Immediately	QuickComm. No	Max: 40.00	

Defines rounding time at start of ramp-down as shown in P1130 (ramp-up initial rounding time).

Note:

Rounding times are recommended, since they prevent an abrupt response, thus avoiding detrimental effects on the mechanics.

Notice:

Rounding times are not recommended when analog inputs are used, since they would result in overshoot/undershoot in the inverter response.

P1133	Ramp-down final rounding time			Min: 0.00	Level: 2
	CStat: CUT	Datatype: Float	Unit: s	Def: 0.00	
	P-Group: SETPOINT	Active: Immediately	QuickComm. No	Max: 40.00	

Defines rounding time at end of ramp-down as shown in P1130 (ramp-up initial rounding time).

Note:

Rounding times are recommended, since they prevent an abrupt response, thus avoiding detrimental effects on the mechanics.

Notice:

Rounding times are not recommended when analog inputs are used, since they would result in overshoot/undershoot in the inverter response.

P1134	Rounding type	Datatype: U16	Unit: -	Min: 0	Level: 2
	CStat: CUT	Active: first confirm	QuickComm. No	Def: 0	
	P-Group: SETPOINT			Max: 1	

Defines smoothing response to OFF commands or setpoint reduction.

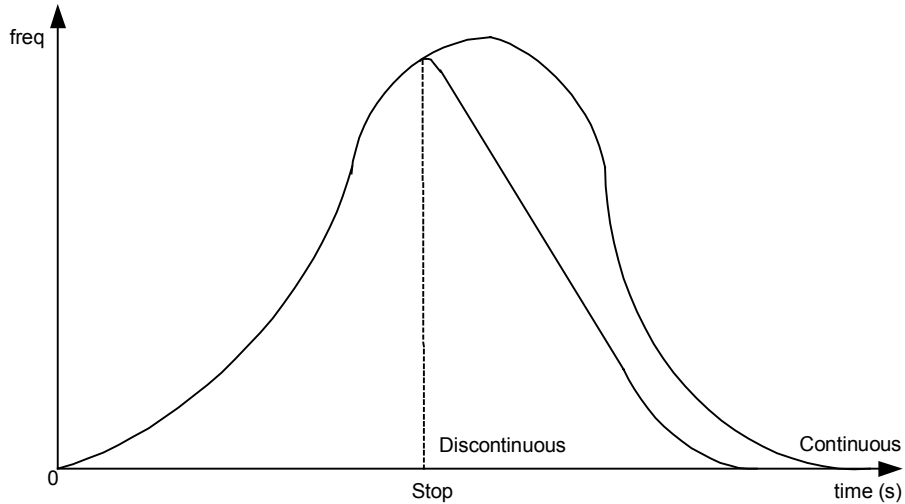

- Enum:**
 0 Continuous smoothing
 1 Discontinuous smoothing

Dependency:
 No effect until total rounding time (P1130) > 0 s.

Notice:
 Rounding times are not recommended when analog inputs are used, since they would result in overshoot/undershoot in the inverter response.

P1135	OFF3 ramp-down time	Datatype: Float	Unit: s	Min: 0.00	Level: 2
	CStat: CUT	Active: Immediately	QuickComm. Yes	Def: 5.00	
	P-Group: SETPOINT			Max: 650.00	

Defines ramp-down time from maximum frequency to standstill for OFF3 command.

Note:
 This time may be exceeded if the VDC_max. level is reached.

P1140	BI: RFG enable	Datatype: U32	Unit: -	Min: 0:0	Level: 4
	CStat: CT	Active: Immediately	QuickComm. No	Def: 1:0	
	P-Group: COMMANDS			Max: 4000:0	

Defines command source of RFG enable command (RFG: ramp function generator).

P1141	BI: RFG start	Datatype: U32	Unit: -	Min: 0:0	Level: 4
	CStat: CT	Active: Immediately	QuickComm. No	Def: 1:0	
	P-Group: COMMANDS			Max: 4000:0	

Defines command source of RFG start command (RFG: ramp function generator).

P1142	BI: RFG enable setpoint	Datatype: U32	Unit: -	Min: 0:0	Level: 4
	CStat: CT	Active: Immediately	QuickComm. No	Def: 1:0	
	P-Group: COMMANDS			Max: 4000:0	

Defines command source of RFG enable setpoint command (RFG: ramp function generator).

r1170	CO: Frequency setpoint after RFG	Datatype: Float	Unit: Hz	Min: -	Level: 3
	CStat: CT	Active: Immediately	QuickComm. No	Def: -	
	P-Group: SETPOINT			Max: -	

Displays overall frequency setpoint after ramp generator.

P1200	Flying start	Datatype: U16	Unit: -	Min: 0	Level: 2
	CStat: CUT	Active: Immediately	QuickComm. No	Def: 0	
	P-Group: FUNC			Max: 6	

Starts inverter onto a spinning motor by rapidly changing the output frequency of the inverter until the actual motor speed has been found. Then, the motor runs up to setpoint using the normal ramp time.

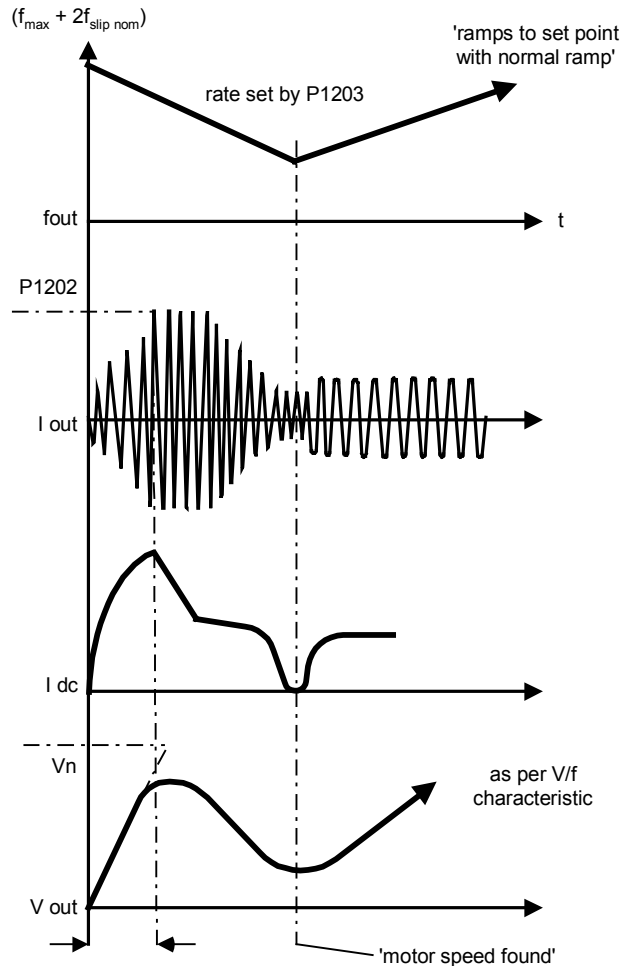
**Enum:**

- 0 Flying start disabled
- 1 Flying start is always active, start in direction of setpoint
- 2 Flying start is active if power on, fault, OFF2, start in direction of setpoint
- 3 Flying start is active if fault, OFF2, start in direction of setpoint
- 4 Flying start is always active, only in direction of setpoint
- 5 Flying start is active if power on, fault, OFF2, only in direction of setpoint
- 6 Flying start is active if fault, OFF2, only in direction of setpoint

Note:

Useful for motors with high inertia loads.

Settings 1 to 3 search in both directions.

Settings 4 to 6 search only in direction of setpoint.

Notice:

Flying start must be used in cases where the motor may still be turning (e.g. after a short mains break) or can be driven by the load. Otherwise, overcurrent trips will occur.

P1202	Motor-current: Flying start	Datatype: U16	Unit: %	Min: 10	Level: 3
	CStat: CUT	Active: Immediately	QuickComm. No	Def: 100	
	P-Group: FUNC			Max: 200	

Defines search current used for flying start.

Value is in [%] based on rated motor current (P0305).

Note:

Reducing the search current may improve performance for flying start if the inertia of the system is not very high.

P1203	Search rate: Flying start	Min: 10	Level: 3	
	CStat: CUT	Datatype: U16		Unit: %
	P-Group: FUNC	Active: Immediately		QuickComm. No Def: 100 Max: 200

Sets factor by which the output frequency changes during flying start to synchronize with turning motor. This value is entered in [%] relative to the default time factor defines the initial gradient in the curve below (and thus influences the time taken to search for the motor frequency):

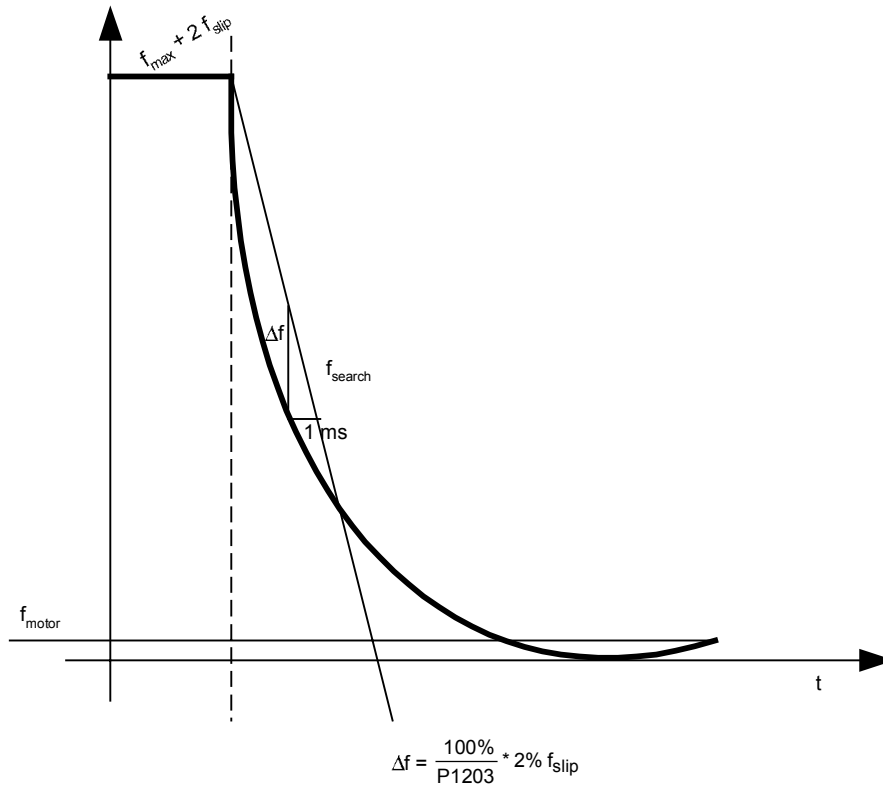

The search time is the time taken to search through all frequencies between $f_{max} + 2 \times f_{slip}$ to 0 Hz.

P1203 = 100 % is defined as giving a rate of 2 % of $f_{slip,nom}$ / [ms]

P1203 = 200 % would result in a rate of frequency change of 1 % of $f_{slip,nom}$ / [ms]

Example:

For a motor with 50 Hz, 1350 rpm, 100 % would produce a maximum search time of 600 ms. If the motor is turning, the motor frequency is found in a shorter time.

Note:

A higher value produces a flatter gradient and thus a longer search time.
A lower value has the opposite effect.

r1204	Status word: Flying start	Min: -	Level: 4	
		Datatype: U16		Unit: -
	P-Group: FUNC			Def: - Max: -

Bit parameter for checking and monitoring states during search.

Bitfields:

Bit00	Current applied	0	NO
		1	YES
Bit01	Current could not be applied	0	NO
		1	YES
Bit02	Voltage reduced	0	NO
		1	YES
Bit03	Slope-filter started	0	NO
		1	YES
Bit04	Current less threshold	0	NO
		1	YES
Bit05	Current-minimum	0	NO
		1	YES
Bit07	Speed could not be found	0	NO
		1	YES

P1210	Automatic restart	Datatype: U16	Unit: -	Min: 0	Level: 2
	CStat: CUT	Active: Immediately	QuickComm. No	Def: 1	
	P-Group: FUNC			Max: 5	

Enables restart after a mains break or after a fault.

Enum:

0	Disabled
1	Trip reset after power on: P1211 disabled
2	Restart mains break; power on: P1211 disabled
3	Restart after fault/mains break: P1211 enabled
4	Restart after mains break: P1211 enabled
5	Restart mains break/fault/power on: P1211 disabled

Dependency:

Auto restart requires constant ON command (e.g. via a digital input wire link).

Caution1:

Settings 2 to 5 can cause the motor to restart unexpectedly !

Notice:

Flying start must be used in cases where the motor may still be turning (e.g. after a short mains break) or can be driven by the load (P1200).

P1211	Number of restart attempts	Datatype: U16	Unit: -	Min: 0	Level: 3
	CStat: CUT	Active: Immediately	QuickComm. No	Def: 3	
	P-Group: FUNC			Max: 10	

Specifies number of times inverter will attempt to restart if P1210 (flying start) is activated.

P1215	Holding brake enable	Datatype: U16	Unit: -	Min: 0	Level: 2
	CStat: T	Active: Immediately	QuickComm. No	Def: 0	
	P-Group: FUNC			Max: 1	

Enables/disables holding brake function. This function applies the following profile to the inverter:

Relay switching is also possible at point 1 and point 2 (if programmed in P0731 = 52.C) to control a brake.

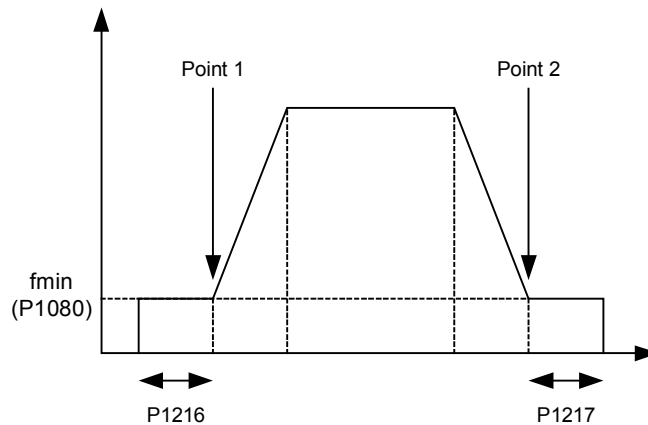
**Enum:**

0	Motor holding brake disabled
1	Motor holding brake enabled

Note:

The brake relay opens at point 1, if enabled using P0731 (function of digital output), and closes at point 2.

P1216	Holding brake release delay	Datatype: Float	Unit: s	Min: 0	Level: 2
	CStat: T	Active: Immediately	QuickComm. No	Def: 1.0	
	P-Group: FUNC			Max: 20.0	

Defines period during which inverter runs at f_{min} before ramping up at point 1 (as shown in P1215 - holding brake enable). Inverter starts at f_{min} on this profile, i.e. it does not use a ramp.

Note:

A typical value of f_{min} for this type of application is the slip frequency of the motor.

You can calculate the rated slip frequency by using the following formula:

$$\frac{n_{syn} - n_n}{n_{syn}} * f_n$$

Notice:

If used to hold the motor at a certain frequency against a mechanical brake (i.e. you are using a relay to control mechanical brake), it is important that $f_{min} < 5$ Hz; otherwise, the current drawn may be too high and the relay may not open.

P1217	Holding time after ramp down	Min: 0	Level:
	CStat: T P-Group: FUNC	Datatype: Float Active: Immediately	Unit: s QuickComm. No
		Def: 1.0 Max: 20.0	2
Defines time for which inverter runs at minimum frequency (P1080) after ramping down at point 2.			
Details: See diagram P1215 (holding brake enable)			
P1230	BI: Enable DC braking	Min: 0:0	Level:
	CStat: CUT P-Group: COMMANDS	Datatype: U32 Active: Immediately	Unit: - QuickComm. No
		Def: 0:0 Max: 4000:0	3
Enables DC braking via a signal applied from an external source. Function remains active while external input signal is active.			
DC braking causes the motor to stop rapidly by applying a DC braking current (current applied also holds shaft stationary).			
When the DC braking signal is applied, the inverter output pulses are blocked and the DC current is not applied until the motor has been sufficiently demagnetized.			
Settings: 722.0 = Digital input 1 (requires P0701 to be set to 99, BICO) 722.1 = Digital input 2 (requires P0702 to be set to 99, BICO) 722.2 = Digital input 3 (requires P0703 to be set to 99, BICO) 722.3 = Digital input 4 (via analog input, requires P0704 to be set to 99)			
Caution2: Frequent use of long periods of DC braking can cause the motor to overheat.			
Notice: This delay time is set in P0347 (demagnetization time). If this delay is too short, overcurrent trips can occur.			
P1232	DC braking current	Min: 0	Level:
	CStat: CUT P-Group: FUNC	Datatype: U16 Active: first confirm	Unit: % QuickComm. No
		Def: 100 Max: 250	2
Defines level of DC current in [%] relative to rated motor current (P0305).			
P1233	Duration of DC braking	Min: 0	Level:
	CStat: CUT P-Group: FUNC	Datatype: U16 Active: first confirm	Unit: s QuickComm. No
		Def: 0 Max: 250	2
Defines duration for which DC injection braking is to be active following an OFF1 command.			
Value: P1233 = 0 : Not active following OFF1. P1233 = 1 - 250 : Active for the specified duration.			
Caution2: Frequent use of long periods of DC braking can cause the motor to overheat.			
Notice: The DC braking function causes the motor to stop rapidly by applying a DC braking current (the current applied also holds the shaft stationary). When the DC braking signal is applied, the inverter output pulses are blocked and the DC current not applied until the motor has been sufficiently demagnetized (demagnetization time is calculated automatically from motor data).			
P1236	Compound braking current	Min: 0	Level:
	CStat: CUT P-Group: FUNC	Datatype: U16 Active: first confirm	Unit: % QuickComm. No
		Def: 0 Max: 250	2
Defines DC level superimposed on AC waveform. The value is entered in [%] relative to rated motor current (P0305)..			
Value: P1236 = 0 : Compound braking disabled. P1236 = 1 - 250 : Level of DC braking current defined as a [%] of rated motor current (P0305).			
Dependency: Active after OFF1 / OFF3 command.			
Notice: Increasing the value will generally improve braking performance; however, if you set the value too high, an overcurrent trip may result.			

P1240	Configuration of Vdc controller	Min: 0	Level:
	CStat: CT Datatype: U16 Unit: - Def: 1 P-Group: FUNC Active: first confirm QuickComm. No Max: 1		3
Enables / disables Vdc controller.			
The Vdc controller dynamically controls the DC link voltage to prevent overvoltage trips on high inertia systems.			
Enum:			
0 Vdc controller disabled			
1 Vdc-max controller enabled			
Note:			
Vdc max automatically increases ramp-down times to keep the DC-link voltage (r0026) within limits (P2172)			
Vdc min is activated if DC-link voltage falls below minimum level. The kinetic energy of the motor is then used to buffer the DC-link voltage, thus causing deceleration of the drive.			
r1242	CO: Switch-on level of Vdc-max	Min: -	Level:
	CStat: - Datatype: Float Unit: V Def: - P-Group: FUNC Active: - QuickComm. No Max: -		3
Displays switch-on level of Vdc max controller.			
P1243	Dynamic factor of Vdc-max	Min: 10	Level:
	CStat: CUT Datatype: U16 Unit: % Def: 100 P-Group: FUNC Active: first confirm QuickComm. No Max: 200		3
Defines dynamic factor for DC link controller in [%].			
Dependency:			
P1243 = 100 % means parameters P1250, P1251 and P1252 (integration time, differential time and output limitation) are used as set. Otherwise, these are multiplied by P1243 (dynamic factor of Vdc-max).			
Note:			
Vdc controller adjustment is calculated automatically from motor and inverter data.			
P1250	Gain of Vdc-controller	Min: 0.00	Level:
	CStat: CUT Datatype: Float Unit: - Def: 1.00 P-Group: FUNC Active: first confirm QuickComm. No Max: 10.00		4
Enters gain for Vdc controller.			
P1251	Integration time Vdc-controller	Min: 0.1	Level:
	CStat: CUT Datatype: Float Unit: ms Def: 40.0 P-Group: FUNC Active: first confirm QuickComm. No Max: 1000.0		4
Enters integral time constant for Vdc controller.			
P1252	Differential time Vdc-controller	Min: 0.0	Level:
	CStat: CUT Datatype: Float Unit: ms Def: 1.0 P-Group: FUNC Active: first confirm QuickComm. No Max: 1000.0		4
Enters differential time constant for Vdc controller.			
P1253	Vdc-controller output limitation	Min: 0	Level:
	CStat: CUT Datatype: Float Unit: Hz Def: 10 P-Group: FUNC Active: first confirm QuickComm. No Max: 600		3
Limits maximum effect of Vdc max controller.			
P1254	Auto detect Vdc switch-on levels	Min: 0	Level:
	CStat: CT Datatype: U16 Unit: - Def: 1 P-Group: FUNC Active: first confirm QuickComm. No Max: 1		3
Enables/disables auto-detection of switch-on levels for Vdc max controller.			
Enum:			
0 Disabled			
1 Enabled			

P1300	Control mode			Min: 0	Level: 2
	CStat: CT	Datatype: U16	Unit: -	Def: 0	
	P-Group: CONTROL	Active: Immediately	QuickComm. Yes	Max: 3	

Controls relationship between speed of motor and voltage supplied by inverter as illustrated in the diagram below

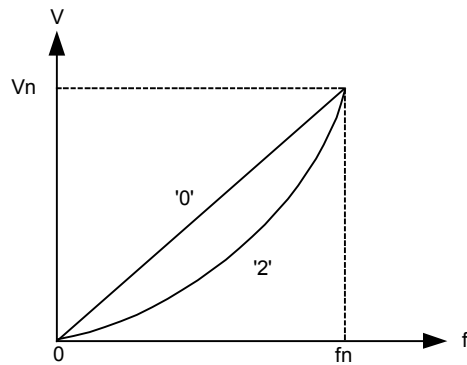
**Enum:**

- 0 V/f with linear charac.
- 1 V/f with FCC
- 2 V/f with parabolic charac.
- 3 V/f with programmable charac.

Note:

- P1300 = 1 : V/f with FCC
 - * Maintains motor flux current for improved efficiency
 - * If FCC is chosen, linear V/f is active at low frequencies.
- P1300 = 2 : V/f with a quadratic curve
 - * Suitable for centrifugal fans / pumps

P1310	Continuous boost	Datatype: Float	Unit: %	Min: 0.0	Level: 2
	CStat: CUT	Active: first confirm	QuickComm. No	Def: 50.0	
	P-Group: CONTROL			Max: 250.0	

Defines boost level in [%] relative to P0305 (rated motor current) applicable to both linear and quadratic V/f curves according to the diagram below:

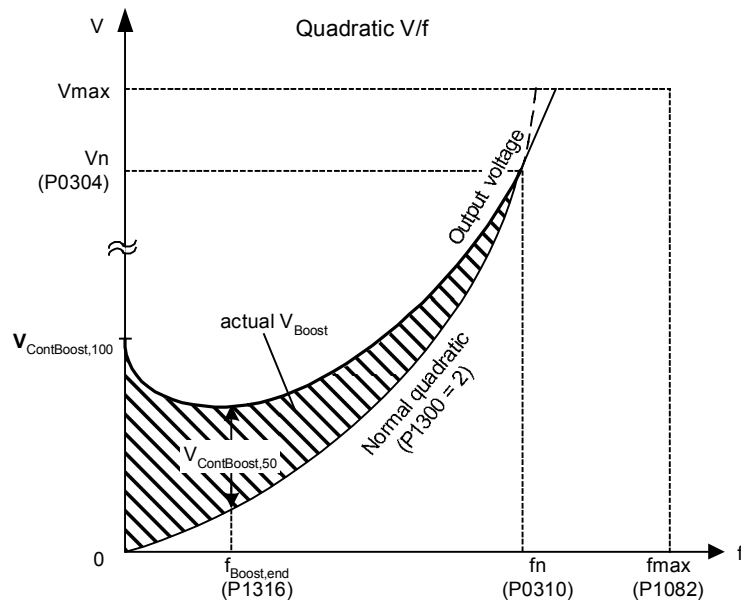
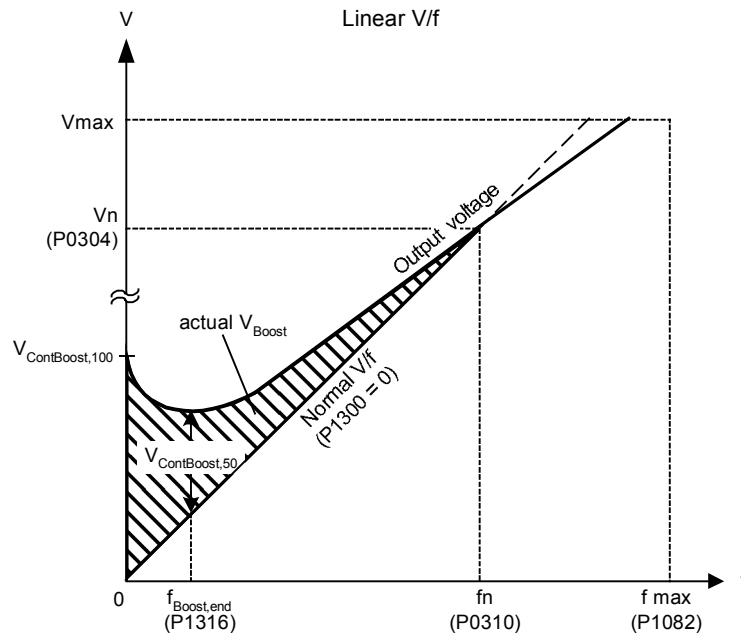

where

$V_{Boost,100}$ = voltage given by rated motor current (P0305) * Stator resistance (P0350)

Dependency:

Setting in P0640 (motor overload factor [%]) limits the boost.

Note:

The boost values are combined when continuous boost (P1310) used in conjunction with other boost parameters (acceleration boost P1311 and starting boost P1312). However priorities are allocated to these parameters as follows:

P1310 > P1311 > P1312

Notice: Increasing the boost levels increases motor heating (especially at standstill).

$$\text{Boosts} \leq \frac{300}{I_{mot}} * R_s$$

P1311	Acceleration boost	Datatype: Float	Unit: %	Min: 0.0	Level: 2
	CStat: CUT	Active: first confirm	QuickComm. No	Def: 0.0	
	P-Group: CONTROL			Max: 250.0	

Applies boost in [%] relative to P0305 (rated motor current) following a positive setpoint change and drops back out once the setpoint is reached.

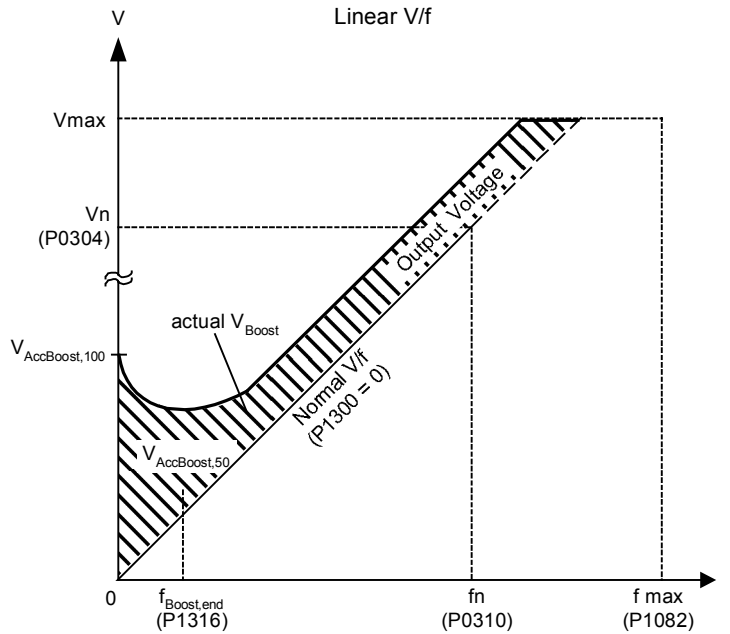

Dependency: Setting in P0640 (motor overload factor [%]) limits boost.

Note: Acceleration boost can help to improve response to small positive setpoint changes.

$$\text{Boosts} \leq \frac{300}{I_{mot}} * R_s$$

Notice: Increasing the boost level increases motor heating.

Details: See note in P1310 for boost priorities.

P1312	Starting boost	Datatype: Float	Unit: %	Min: 0.0	Level: 2
	CStat: CUT	Active: first confirm	QuickComm. No	Def: 0.0	
	P-Group: CONTROL			Max: 250.0	

Applies a constant linear offset (in [%] relative to P0305 (rated motor current)) to active V/f curve (either linear or quadratic) after an ON command and is active until setpoint is reached for the first time. This is useful for starting loads with high inertia.

Setting the starting boost (P1312) too high will cause the inverter to limit the current, which will in turn restrict the output frequency to below the setpoint frequency.

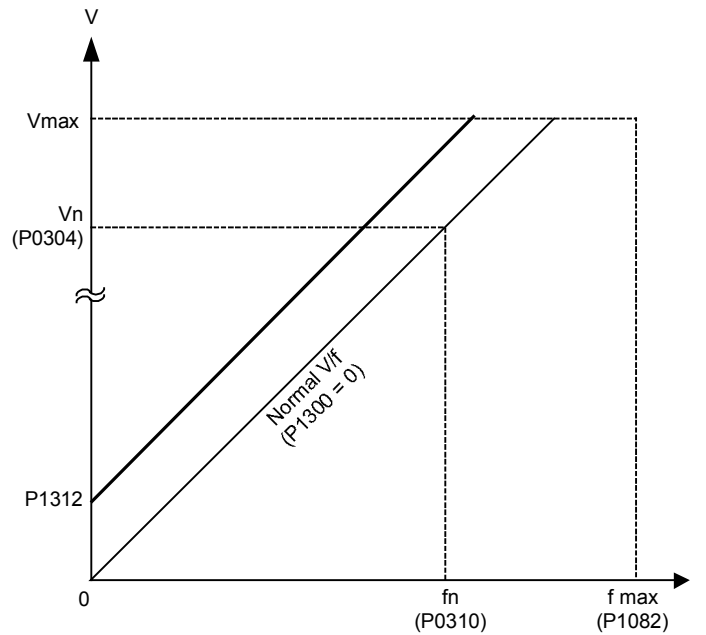
**Dependency:**

Setting in P0640 (motor overload factor [%]) limits boost.

Notice:

Increasing the boost levels increases motor heating.

$$\text{Boosts} \leq \frac{300}{I_{\text{mot}}} * R_s$$

Details:

See note in P1310 for boost priorities.

r1315	CO: Total boost voltage	Datatype: Float	Unit: V	Min: -	Level: 4
	P-Group: CONTROL			Def: -	
				Max: -	

Displays total value of voltage boost (in volts).

P1316	Boost end frequency	Datatype: Float	Unit: %	Min: 0.0	Level: 3
	CStat: CUT	Active: first confirm	QuickComm. No	Def: 20.0	
	P-Group: CONTROL			Max: 100.0	

Defines point at which programmed boost reaches 50 % of its value.

This value is expressed in [%] relative to P0310 (rated motor frequency).

This frequency is defined as follows:

$$f_{\text{Boost min}} = 2 * \left(\frac{153}{\sqrt{P_{\text{motor}}}} + 3 \right)$$

It is displayed as [%] value of the f_nominal.

Note:

The expert user may change this value to alter the shape of the curve, e.g. to increase torque at a particular frequency.

Details:

See diagram in P1310 (continuous boost)

P1320	Programmable V/f freq. coord. 1			Min: 0.00	Level: 3
	CStat: CT	Datatype: Float	Unit: Hz	Def: 0.00	
	P-Group: CONTROL	Active: first confirm	QuickComm. No	Max: 650.00	

Sets V/f coordinates (P1320/1321 to P1324/1325) to define V/f characteristic.

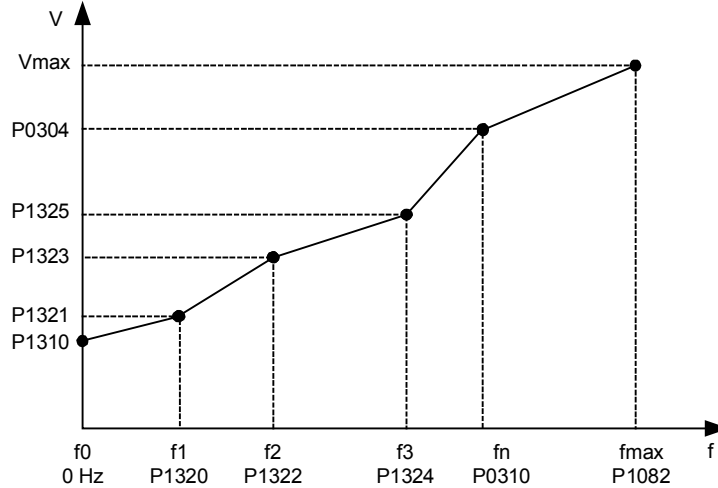

$$P1310[V] = \frac{P1310[\%]}{100[\%]} \cdot \frac{r0395[\%]}{100[\%]} \cdot P0304[V]$$

Example:

This parameter can be used to provide correct torque at correct frequency and is useful when used with synchronous motors.

Dependency:

To set parameter, select P1300 = 3 (V/f with programmable characteristic)

Note:

Linear interpolation will be applied between points set from P1320/1321 to P1324/1325.

V/f with programmable characteristic (P1300 = 3) has 3 programmable points. The two non-programmable points are:

- Boost voltage P1310 at zero 0 Hz
- Nominal voltage at nominal frequency

The acceleration boost and starting boost defined in P1311 and P1312 are applied to V/f with programmable characteristic.

P1321	Programmable V/f volt. coord. 1			Min: 0.0	Level: 3
	CStat: CUT	Datatype: Float	Unit: V	Def: 0.0	
	P-Group: CONTROL	Active: first confirm	QuickComm. No	Max: 3000.0	

See P1320 (programmable V/f freq. coord. 1).

P1322	Programmable V/f freq. coord. 2			Min: 0.00	Level: 3
	CStat: CT	Datatype: Float	Unit: Hz	Def: 0.00	
	P-Group: CONTROL	Active: first confirm	QuickComm. No	Max: 650.00	

See P1320 (programmable V/f freq. coord. 1).

P1323	Programmable V/f volt. coord. 2			Min: 0.0	Level: 3
	CStat: CUT	Datatype: Float	Unit: V	Def: 0.0	
	P-Group: CONTROL	Active: first confirm	QuickComm. No	Max: 3000.0	

See P1320 (programmable V/f freq. coord. 1).

P1324	Programmable V/f freq. coord. 3			Min: 0.00	Level: 3
	CStat: CT	Datatype: Float	Unit: Hz	Def: 0.00	
	P-Group: CONTROL	Active: first confirm	QuickComm. No	Max: 650.00	

See P1320 (programmable V/f freq. coord. 1).

P1325	Programmable V/f volt. coord. 3			Min: 0.0	Level: 3
	CStat: CUT	Datatype: Float	Unit: V	Def: 0.0	
	P-Group: CONTROL	Active: first confirm	QuickComm. No	Max: 3000.0	

See P1320 (programmable V/f freq. coord. 1).

P1333	Start frequency for FCC	Min: 0.0	Level:
	CStat: CUT Datatype: Float Unit: % Def: 10.0 P-Group: CONTROL Active: first confirm QuickComm. No Max: 100.0		3
Defines start frequency at which FCC (flux current control) is enabled as [%] of rated motor frequency (P0310).			
Notice: If this value is too low, the system may become unstable.			
P1335	Slip compensation	Min: 0.0	Level:
	CStat: CUT Datatype: Float Unit: % Def: 0.0 P-Group: CONTROL Active: first confirm QuickComm. No Max: 600.0		2
Dynamically adjusts output frequency of inverter so that motor speed is kept constant independent of motor load.			
Value: P1335 = 0 % : Slip compensation disabled. P1335 = 100 % : This uses the motor data and motor model to add the rated slip frequency rated motor speed and rated motor current.			
Note: Gain adjustment enables fine-tuning of the actual motor speed (see P1460 - gain speed control). 100% = standard setting for warm stator			
P1336	Slip limit	Min: 0	Level:
	CStat: CUT Datatype: U16 Unit: % Def: 250 P-Group: CONTROL Active: first confirm QuickComm. No Max: 600		2
Compensation slip limit in [%] relative to r0330 (rated motor slip), which is added to frequency setpoint.			
Dependency: Slip compensation (P1335) active.			
r1337	CO: V/f slip frequency	Min: -	Level:
	Datatype: Float Unit: % Def: - P-Group: CONTROL Max: -		3
Displays actual compensated motor slip as [%]			
Dependency: Slip compensation (P1335) active.			
P1338	Resonance damping gain V/f	Min: 0.00	Level:
	CStat: CUT Datatype: Float Unit: - Def: 0.00 P-Group: CONTROL Active: first confirm QuickComm. No Max: 10.00		3
Defines resonance damping gain for V/f.			
Note: The resonance circuit damps oscillations of the active current which frequently occur during no-load operation. In V/f modes (see P1300), the resonant damping circuit is active in a range from approx. 5 % to 70 % of rated motor frequency (P0310).			
P1340	I_{max} controller prop. gain	Min: 0.000	Level:
	CStat: CUT Datatype: Float Unit: - Def: 0.000 P-Group: CONTROL Active: first confirm QuickComm. No Max: 0.499		3
Proportional gain of the I _{max} controller.			
Dynamically controls the inverter if the output current exceeds the maximum motor current (P0067). It does this by first limiting the inverter output frequency (to a possible minimum of the nominal slip frequency). If this action does not successfully remove the overcurrent condition, the inverter output voltage is reduced. When the overcurrent condition has been removed successfully, frequency limiting is removed using the ramp-up time set in P1120.			
P1341	I_{max} controller integral time	Min: 0.000	Level:
	CStat: CUT Datatype: Float Unit: s Def: 0.300 P-Group: CONTROL Active: first confirm QuickComm. No Max: 50.000		3
Integral time constant of the I _{max} controller. P1341 = 0 : I _{max} controller disabled P1340 = 0 and P1341 > 0 : enhanced integral P1340 > 0 and P1341 > 0 : normal PI control			
See description in parameter P1340 for further information.			

r1343	CO: I_{max} controller freq. output	Datatype: Float	Unit: Hz	Min: -	Def: -	Level: 3
	P-Group: CONTROL			Max: -		
	Displays effective frequency limitation.					
	Dependency: If I _{max} controller not in operation, parameter normally shows f _{max} (P1082).					
r1344	CO: I_{max} controller volt. output	Datatype: Float	Unit: V	Min: -	Def: -	Level: 3
	P-Group: CONTROL			Max: -		
	Displays amount by which the I _{max} controller is reducing the inverter output voltage.					
P1350	Voltage soft start	Datatype: U16	Unit: -	Min: 0	Def: 0	Level: 3
	CStat: CUT	Active: Immediately	QuickComm. No	Max: 1		
	Sets whether voltage is built up smoothly during magnetization time (ON) or whether it simply jumps to boost voltage (OFF)					
	Enum:					
	0	OFF				
	1	ON				
	Note:					
	The settings for this parameter bring benefits and drawbacks:					
	0 = OFF (jump to boost voltage)					
	Benefit: flux is built up quickly					
	Drawback: motor may move					
	1 = ON (smooth voltage build-up)					
	Benefit: motor less likely to move					
	Drawback: flux build-up takes longer					
P1800	Pulse frequency	Datatype: U16	Unit: kHz	Min: 2	Def: 4	Level: 2
	CStat: CUT	Active: first confirm	QuickComm. No	Max: 16		
	Sets pulse frequency of power switches in inverter. The frequency can be changed in steps of 2 kHz.					
	Pulse frequencies > 4 kHz selected on 380-480 V units reduce the maximum continuous motor current.					
	Dependency: Minimum pulse frequency depends on P1082 (maximum frequency) and P0310 (rated motor frequency).					
	Note:					
	At 4 kHz, full output current is obtained up to 50 degrees C (CT mode); over 50 degrees C, full output may be obtained at 8 kHz					
	If silent operation is not absolutely necessary, lower pulse frequencies may be selected to reduce inverter losses and radio-frequency emissions.					
	Under certain circumstances, the inverter may reduce the switching frequency to provide protection against over-temperature (see P0290, Level 3).					
r1801	CO: Act. switching frequency	Datatype: U16	Unit: kHz	Min: -	Def: -	Level: 3
	P-Group: INVERTER			Max: -		
	Actual pulse frequency of power switches in inverter.					
	Notice:					
	Under certain conditions (inverter overtemperature, see P0290), this can differ from the values selected in P1800 (pulse frequency).					
P1802	Modulator mode	Datatype: U16	Unit: -	Min: 0	Def: 0	Level: 3
	CStat: CUT	Active: Immediately	QuickComm. No	Max: 2		
	Selects inverter modulator mode.					
	Enum:					
	0	SVM/ASVM automatic mode				
	1	Asymmetric SVM				
	2	Space vector modulation				
	Notice:					
	Asymmetric space vector modulation (ASVM) produces lower switching losses than space vector modulation (SVM), but may cause irregular rotation at very low speeds.					
	Space vector modulation (SVM) with over-modulation may produce current waveform distortion at high output voltages.					
	Space vector modulation (SVM) without over-modulation will reduce maximum output voltage available to motor.					

P1803	Max. modulation	Datatype: Float	Unit: %	Min: 20.0	Level: 4
	CStat: CUT P-Group: INVERTER	Active: first confirm	QuickComm. No	Def: 106.0 Max: 150.0	
Sets maximum modulation index.					
Note: P1803 = 100 % = limit for over-control (for ideal inverter without switching delay). For vector control the modulation limit will be reduced automatically with 4 %.					
P1820	Reverse output phase sequence	Datatype: U16	Unit: -	Min: 0	Level: 2
	CStat: CT P-Group: INVERTER	Active: Immediately	QuickComm. No	Def: 0 Max: 1	
Changes direction of motor rotation without changing setpoint polarity.					
Enum: 0 OFF 1 ON					
Dependency: If positive and negative revolution is enabled, frequency setpoint is directly used. If both positive and negative revolution are disabled, reference value is set to zero.					
Details: See P1000 (select frequency setpoint)					
P1910	Select motor data identification	Datatype: U16	Unit: -	Min: 0	Level: 2
	CStat: CT P-Group: MOTOR	Active: Immediately	QuickComm. Yes	Def: 0 Max: 2	
Performs stator resistance measuring.					
Enum: 0 Disabled 1 Identification of Rs with parameter change 2 Identification of Rs without parameter change					
Dependency: No measurement if motor data incorrect.					
P1910 = 1 : Calculated value for stator resistance (see P0350) is overwritten.					
P1910 = 2 : Values already calculated are not overwritten.					
Note: Before selecting motor data identification, "Quick commissioning" has to be performed in advance.					
Once enabled (P1910 = 1), A0541 generates a warning that the next ON command will initiate measurement of motor parameters.					
Notice: When choosing the setting for measurement, observe the following: 1. "with parameter change" means that the value is actually adopted as P0350 parameter setting and applied to the control as well as being shown in the read-only parameters below. 2. "without parameter change" means that the value is only displayed, i.e. shown for checking purposes in the read-only parameter r1912 (identified stator resistance). The value is not applied to the control.					
r1912	Identified stator resistance	Datatype: Float	Unit: Ohm	Min: -	Level: 2
	P-Group: MOTOR			Def: - Max: -	
Displays measured stator resistance value (line-to-line) in [Ohms]					
Note: This value is measured using P1910 = 1 or 2 , i.e., identification of all parameters with/without change.					
P2000	Reference frequency	Datatype: Float	Unit: Hz	Min: 1.00	Level: 2
	CStat: CT P-Group: COMM	Active: Immediately	QuickComm. No	Def: 50.00 Max: 650.00	
Full-scale frequency setting used by serial link (corresponds to 4000H), analog I/O and P/D controller.					
P2001	Reference voltage	Datatype: U16	Unit: V	Min: 10	Level: 3
	CStat: CT P-Group: COMM	Active: Immediately	QuickComm. No	Def: 1000 Max: 2000	
Full-scale output voltage (i.e. 100 %) used over serial link (corresponds to 4000H).					
Example: P0201 = 230 specifies that 4000H received via USS denotes 230 V.					
P2002	Reference current	Datatype: Float	Unit: A	Min: 0.10	Level: 3
	CStat: CT P-Group: COMM	Active: Immediately	QuickComm. No	Def: 0.10 Max: 10000.00	
Full-scale output current used over serial link (corresponds to 4000H).					

P2009[2]	USS normalization	Datatype: U16	Unit: -	Min: 0	Level: 3
	CStat: CT P-Group: COMM	Active: Immediately	QuickComm. No	Def: 0 Max: 1	
Enables special normalization for USS.					
Enum:					
0 Disabled					
1 Enabled					
Index:					
P2009[0] : Serial interface COM link					
P2009[1] : Serial interface BOP link					
Note:					
If enabled, the main setpoint (word 2 in PZD) is not interpreted as 100 % = 4000H, but as "absolute" instead (e.g. 4000H = 16384 means 163.84 Hz).					
P2010[2]	USS baudrate	Datatype: U16	Unit: -	Min: 3	Level: 2
	CStat: CUT P-Group: COMM	Active: Immediately	QuickComm. No	Def: 6 Max: 9	
Sets baud rate for USS communication.					
Enum:					
3 1200 baud					
4 2400 baud					
5 4800 baud					
6 9600 baud					
7 19200 baud					
8 38400 baud					
9 57600 baud					
Index:					
P2010[0] : Serial interface COM link					
P2010[1] : Serial interface BOP link					
P2011[2]	USS address	Datatype: U16	Unit: -	Min: 0	Level: 2
	CStat: CUT P-Group: COMM	Active: Immediately	QuickComm. No	Def: 0 Max: 31	
Sets unique address for inverter.					
Index:					
P2011[0] : Serial interface COM link					
P2011[1] : Serial interface BOP link					
Note:					
You can connect up to a further 30 inverters via the serial link (i.e. 31 inverters in total) and control them with the USS serial bus protocol.					
P2012[2]	USS PZD length	Datatype: U16	Unit: -	Min: 0	Level: 3
	CStat: CUT P-Group: COMM	Active: Immediately	QuickComm. No	Def: 2 Max: 4	
Defines the number of 16-bit words in PZD part of USS telegram. The PZD part of the USS telegram is used for the main setpoint, and to control the inverter.					
Index:					
P2012[0] : Serial interface COM link					
P2012[1] : Serial interface BOP link					
P2013[2]	USS PKW length	Datatype: U16	Unit: -	Min: 0	Level: 3
	CStat: CUT P-Group: COMM	Active: Immediately	QuickComm. No	Def: 127 Max: 127	
Defines the number of 16-bit words in PKW part of USS telegram. The PKW part of the USS telegram is used to read and write individual parameter values					
Enum:					
0 No words					
3 3 words					
4 4 words					
27 Variable					
Index:					
P2013[0] : Serial interface COM link					
P2013[1] : Serial interface BOP link					
Notice:					
Setting P2013 has implications for the PKW word order, please refer to the Reference Manual for details					

P2014[2]	USS telegram off time	CStat: CT	Datatype: U16	Unit: ms	Min: 0	Def: 0	Max: 65535	Level: 3
		P-Group: COMM	Active: first confirm	QuickComm. No				
	Defines a time T_off after which a fault will be generated (F0070) if no telegram is received via the USS channels.							
Index:	P2014[0] : Serial interface COM link P2014[1] : Serial interface BOP link							
Notice:	By default (time set to 0), no fault is generated (i.e. watchdog disabled).							
r2015[4]	CO: PZD from BOP link (USS)	CStat: CT	Datatype: U16	Unit: -	Min: -	Def: -	Max: -	Level: 3
		P-Group: COMM						
	Displays process data received via USS on BOP link (RS232 USS).							
Index:	r2015[0] : Received word 0 r2015[1] : Received word 1 r2015[2] : Received word 2 r2015[3] : Received word 3							
Note:	The control words can be viewed as bit parameters r2032 and r2033.							
P2016[4]	CI: PZD to BOP link (USS)	CStat: CT	Datatype: U32	Unit: -	Min: 0:0	Def: 52:0	Max: 4000:0	Level: 3
		P-Group: COMM	Active: first confirm	QuickComm. No				
	Selects signals to be transmitted to serial interface via BOP link							
Example:	P2016[0] = 52.0 (default). In this case, the value of r0052[0] (CO/BO: Status word) is transmitted as 1st PZD to the BOP link.							
Index:	P2016[0] : Transmitted word 0 P2016[1] : Transmitted word 1 P2016[2] : Transmitted word 2 P2016[3] : Transmitted word 3							
Note:	If r0052 not indexed, display does not show an index (".0").							
r2018[4]	CO: PZD from COM link (USS)	CStat: CT	Datatype: U16	Unit: -	Min: -	Def: -	Max: -	Level: 3
		P-Group: COMM						
	Displays process data received via USS on COM link							
Index:	r2018[0] : Received word 0 r2018[1] : Received word 1 r2018[2] : Received word 2 r2018[3] : Received word 3							
Note:	The control words can be viewed as bit parameters r2032 and r2033.							
P2019[4]	CI: PZD to COM link (USS)	CStat: CT	Datatype: U32	Unit: -	Min: 0:0	Def: 52:0	Max: 4000:0	Level: 3
		P-Group: COMM	Active: first confirm	QuickComm. No				
Index:	P2019[0] : Transmitted word 0 P2019[1] : Transmitted word 1 P2019[2] : Transmitted word 2 P2019[3] : Transmitted word 3							
Details:	See r2016 (PZD to BOP link)							
r2024[2]	USS error-free telegrams	CStat: CT	Datatype: U16	Unit: -	Min: -	Def: -	Max: -	Level: 3
		P-Group: COMM						
	Displays number of error-free USS telegrams received.							
Index:	r2024[0] : Serial interface COM link r2024[1] : Serial interface BOP link							

r2025[2]	USS rejected telegrams	Datatype: U16	Unit: -	Min: - Def: - Max: -	Level: 3
	P-Group: COMM				
	Displays number of USS telegrams rejected.				
Index:	r2025[0] : Serial interface COM link r2025[1] : Serial interface BOP link				
r2026[2]	USS character frame error	Datatype: U16	Unit: -	Min: - Def: - Max: -	Level: 3
	P-Group: COMM				
	Displays number of USS character frame errors.				
Index:	r2026[0] : Serial interface COM link r2026[1] : Serial interface BOP link				
r2027[2]	USS overrun error	Datatype: U16	Unit: -	Min: - Def: - Max: -	Level: 3
	P-Group: COMM				
	Displays number of USS telegrams with overrun error.				
Index:	r2027[0] : Serial interface COM link r2027[1] : Serial interface BOP link				
r2028[2]	USS parity error	Datatype: U16	Unit: -	Min: - Def: - Max: -	Level: 3
	P-Group: COMM				
	Displays number of USS telegrams with parity error.				
Index:	r2028[0] : Serial interface COM link r2028[1] : Serial interface BOP link				
r2029[2]	USS start not identified	Datatype: U16	Unit: -	Min: - Def: - Max: -	Level: 3
	P-Group: COMM				
	Displays number of USS telegrams with unidentified start.				
Index:	r2029[0] : Serial interface COM link r2029[1] : Serial interface BOP link				
r2030[2]	USS BCC error	Datatype: U16	Unit: -	Min: - Def: - Max: -	Level: 3
	P-Group: COMM				
	Displays number of USS telegrams with BCC error.				
Index:	r2030[0] : Serial interface COM link r2030[1] : Serial interface BOP link				
r2031[2]	USS length error	Datatype: U16	Unit: -	Min: - Def: - Max: -	Level: 3
	P-Group: COMM				
	Displays number of USS telegrams with incorrect length.				
Index:	r2031[0] : Serial interface COM link r2031[1] : Serial interface BOP link				

r2032	BO: CtrlWrd1 from BOP link (USS)			Min: -	Level: 3
	Datatype: U16	Unit: -	Def: -	Max: -	
	P-Group: COMM				
	Displays control word 1 from BOP link (word 1 within USS).				
	Bitfields:				
	Bit00	ON/OFF1	0	NO	
			1	YES	
	Bit01	OFF2: Electrical stop	0	YES	
			1	NO	
	Bit02	OFF3: Fast stop	0	YES	
			1	NO	
	Bit03	Pulse enable	0	NO	
			1	YES	
	Bit04	RFG enable	0	NO	
			1	YES	
	Bit05	RFG start	0	NO	
			1	YES	
	Bit06	Setpoint enable	0	NO	
			1	YES	
	Bit07	Fault acknowledge	0	NO	
			1	YES	
	Bit08	JOG right	0	NO	
			1	YES	
	Bit09	JOG left	0	NO	
			1	YES	
	Bit10	Control from PLC	0	NO	
			1	YES	
	Bit11	Reverse (setpoint inversion)	0	NO	
			1	YES	
	Bit13	Motor potentiometer MOP up	0	NO	
			1	YES	
	Bit14	Motor potentiometer MOP down	0	NO	
			1	YES	
	Bit15	Local / Remote	0	NO	
			1	YES	

r2033	BO: CtrlWrd2 from BOP link (USS)			Min: -	Level: 3
	Datatype: U16	Unit: -	Def: -	Max: -	
	P-Group: COMM				
	Displays control word 2 from BOP link (i.e. word 4 within USS)				
	Bitfields:				
	Bit00	Fixed frequency Bit 0	0	NO	
			1	YES	
	Bit01	Fixed frequency Bit 1	0	NO	
			1	YES	
	Bit02	Fixed frequency Bit 2	0	NO	
			1	YES	
	Bit08	PID enabled	0	NO	
			1	YES	
	Bit09	DC brake enabled	0	NO	
			1	YES	
	Bit13	External fault 1	0	YES	
			1	NO	
	Dependency:				
	P0700 = 5 (USS on COM link) and P0719 = 0 (Cmd / Setpoint = BICO parameter).				

r2036	BO: CtrlWrd1 from COM link (USS)	Datatype: U16	Unit: -	Min: -	Level: 3
	P-Group: COMM			Def: - Max: -	

Displays control word 1 from COM link (i.e. word 1 within USS)

Bitfields:

Bit00	ON/OFF1	0	NO
		1	YES
Bit01	OFF2: Electrical stop	0	YES
		1	NO
Bit02	OFF3: Fast stop	0	YES
		1	NO
Bit03	Pulse enable	0	NO
		1	YES
Bit04	RFG enable	0	NO
		1	YES
Bit05	RFG start	0	NO
		1	YES
Bit06	Setpoint enable	0	NO
		1	YES
Bit07	Fault acknowledge	0	NO
		1	YES
Bit08	JOG right	0	NO
		1	YES
Bit09	JOG left	0	NO
		1	YES
Bit10	Control from PLC	0	NO
		1	YES
Bit11	Reverse (setpoint inversion)	0	NO
		1	YES
Bit13	Motor potentiometer MOP up	0	NO
		1	YES
Bit14	Motor potentiometer MOP down	0	NO
		1	YES
Bit15	Local / Remote	0	NO
		1	YES

Details:

See r2033 (control word 2 from BOP link)

r2037	BO: CtrlWrd2 from COM link (USS)	Datatype: U16	Unit: -	Min: -	Level: 3
	P-Group: COMM			Def: - Max: -	

Displays control word 2 from COM link (i.e. word 4 within USS)

Bitfields:

Bit00	Fixed frequency Bit 0	0	NO
		1	YES
Bit01	Fixed frequency Bit 1	0	NO
		1	YES
Bit02	Fixed frequency Bit 2	0	NO
		1	YES
Bit08	PID enabled	0	NO
		1	YES
Bit09	DC brake enabled	0	NO
		1	YES
Bit13	External fault 1	0	YES
		1	NO

Details:

See r2033 (control word 2 from BOP link)

P2040	CB telegram off time			Min: 0	Level: 3
	CStat: CT	Datatype: U16	Unit: ms	Def: 20	
	P-Group: COMM	Active: first confirm	QuickComm. No	Max: 65535	

Defines time after which a fault will be generated (F0070) if no telegram is received via the link (SOL).

Dependency:

Setting 0 = watchdog disabled

P2041[5]	CB parameter	Datatype: U16	Unit: -	Min: 0 Def: 0 Max: 65535	Level: 3
	CStat: CT	Active: Immediately	QuickComm. No		
	P-Group: COMM				
	Configures a communication board (CB).				
Index:	P2041[0] : CB parameter 0 P2041[1] : CB parameter 1 P2041[2] : CB parameter 2 P2041[3] : CB parameter 3 P2041[4] : CB parameter 4				
Details:	See relevant communication board manual for protocol definition and appropriate settings				
r2050[4]	CO: PZD from CB	Datatype: U16	Unit: -	Min: - Def: - Max: -	Level: 3
	P-Group: COMM				
	Displays PZD received from communication board (CB).				
Index:	r2050[0] : Received word 0 r2050[1] : Received word 1 r2050[2] : Received word 2 r2050[3] : Received word 3				
Note:	The control words can be viewed as bit parameters r2032 and r2033.				
P2051[4]	CI: PZD to CB	Datatype: U32	Unit: -	Min: 0:0 Def: 52:0 Max: 4000:0	Level: 3
	CStat: CT	Active: first confirm	QuickComm. No		
	P-Group: COMM				
	Connects PZD to CB.				
	This parameter allows the user to define the source of status words and actual values for the reply PZD.				
Settings:	Status word 1 = 52 CO/BO: Act. status word 1 (see r0052) Actual value 1 = 21 inverter output frequency (see r0021)				
	Other BICO settings are possible				
Index:	P2051[0] : Transmitted word 0 P2051[1] : Transmitted word 1 P2051[2] : Transmitted word 2 P2051[3] : Transmitted word 3				
r2053[5]	CB identification	Datatype: U16	Unit: -	Min: - Def: - Max: -	Level: 3
	P-Group: COMM				
	Displays identification data of the communication board (CB). The different CB types (r2035[0]) are given in the Enum declaration.				
Enum:	0 No CB option board 1 PROFIBUS DP 2 DeviceNet 56 not defined				
Index:	r2053[0] : CB type (PROFIBUS = 1) r2053[1] : Firmware version r2053[2] : Firmware version detail r2053[3] : Firmware date (year) r2053[4] : Firmware date (day/month)				
r2054[7]	CB diagnosis	Datatype: U16	Unit: -	Min: - Def: - Max: -	Level: 3
	P-Group: COMM				
	Displays diagnostic information of communication board (CB).				
Index:	r2054[0] : CB diagnosis 0 r2054[1] : CB diagnosis 1 r2054[2] : CB diagnosis 2 r2054[3] : CB diagnosis 3 r2054[4] : CB diagnosis 4 r2054[5] : CB diagnosis 5 r2054[6] : CB diagnosis 6				
Details:	See relevant communications board manual.				

r2090	BO: Control word 1 from CB	Datatype: U16	Unit: -	Min: -	Level: 3
	P-Group: COMM			Def: - Max: -	

Displays control word 1 received from communication board (CB).

Bitfields:

Bit00	ON/OFF1	0	NO
		1	YES
Bit01	OFF2: Electrical stop	0	YES
		1	NO
Bit02	OFF3: Fast stop	0	YES
		1	NO
Bit03	Pulse enable	0	NO
		1	YES
Bit04	RFG enable	0	NO
		1	YES
Bit05	RFG start	0	NO
		1	YES
Bit06	Setpoint enable	0	NO
		1	YES
Bit07	Fault acknowledge	0	NO
		1	YES
Bit08	JOG right	0	NO
		1	YES
Bit09	JOG left	0	NO
		1	YES
Bit10	Control from PLC	0	NO
		1	YES
Bit11	Reverse (setpoint inversion)	0	NO
		1	YES
Bit13	Motor potentiometer MOP up	0	NO
		1	YES
Bit14	Motor potentiometer MOP down	0	NO
		1	YES
Bit15	Local / Remote	0	NO
		1	YES

Details:

See relevant communication board manual for protocol definition and appropriate settings

r2091	BO: Control word 2 from CB	Datatype: U16	Unit: -	Min: -	Level: 3
	P-Group: COMM			Def: - Max: -	

Displays control word 2 received from communication board (CB).

Bitfields:

Bit00	Fixed frequency Bit 0	0	NO
		1	YES
Bit01	Fixed frequency Bit 1	0	NO
		1	YES
Bit02	Fixed frequency Bit 2	0	NO
		1	YES
Bit08	PID enabled	0	NO
		1	YES
Bit09	DC brake enabled	0	NO
		1	YES
Bit13	External fault 1	0	YES
		1	NO

Details:

See relevant communication board manual for protocol definition and appropriate settings

P2100[3]	Alarm number selection	Datatype: U16	Unit: -	Min: 0	Level: 3
	CStat: CT	Active: Immediately	QuickComm. No	Def: 0 Max: 65535	

Selects up to 3 faults or warnings for non-default reactions.

Example:

If you want F0005 to perform an OFF3 instead of an OFF2, set P2100[0] = 5, then select the desired reaction in P2101[0] (in this case, set P2101[0] = 3).

Note:

All fault codes have a default reaction to OFF2. Some fault codes caused by hardware trips (e.g. overcurrent) cannot be changed from the default reactions.

P2101[3]	Stop reaction value	Min: 0	Level:
	CStat: CT Datatype: U16 Unit: - Def: 0 P-Group: ALARMS Active: Immediately QuickComm. No Max: 4		3
Sets drive stop reaction values for fault selected by P2100 (alarm number stop reaction).			
This indexed parameter specifies the special reaction to the faults/warnings defined in P2100 indices 0 to 2.			
Enum:			
	0 No reaction, no display		
	1 OFF1 stop reaction		
	2 OFF2 stop reaction		
	3 OFF3 stop reaction		
	4 No reaction warning only		
Note:			
Settings 0 - 3 only are available for fault codes			
Settings 0 and 4 only are available for warnings			
Index 0 (P2101) refers to fault/warning in index 0 (P2100)			
P2103	BI: 1. Faults acknowledgement	Min: 0:0	Level:
	CStat: CT Datatype: U32 Unit: - Def: 722:2 P-Group: COMMANDS Active: Immediately QuickComm. No Max: 4000:0		3
Defines source of fault acknowledgement, e.g. keypad/DIN, etc. (depending on setting).			
Settings:			
	722.0 = Digital input 1 (requires P0701 to be set to 99, BICO)		
	722.1 = Digital input 2 (requires P0702 to be set to 99, BICO)		
	722.2 = Digital input 3 (requires P0703 to be set to 99, BICO)		
	722.3 = Digital input 4 (via analog input, requires P0704 to be set to 99)		
P2104	BI: 2. Faults acknowledgement	Min: 0:0	Level:
	CStat: CT Datatype: U32 Unit: - Def: 0:0 P-Group: COMMANDS Active: Immediately QuickComm. No Max: 4000:0		3
Selects second source of fault acknowledgement.			
Settings:			
	722.0 = Digital input 1 (requires P0701 to be set to 99, BICO)		
	722.1 = Digital input 2 (requires P0702 to be set to 99, BICO)		
	722.2 = Digital input 3 (requires P0703 to be set to 99, BICO)		
	722.3 = Digital input 4 (via analog input, requires P0704 to be set to 99)		
P2106	BI: External fault	Min: 0:0	Level:
	CStat: CT Datatype: U32 Unit: - Def: 1:0 P-Group: COMMANDS Active: Immediately QuickComm. No Max: 4000:0		3
Selects source of external faults.			
Settings:			
	722.0 = Digital input 1 (requires P0701 to be set to 99, BICO)		
	722.1 = Digital input 2 (requires P0702 to be set to 99, BICO)		
	722.2 = Digital input 3 (requires P0703 to be set to 99, BICO)		
	722.3 = Digital input 4 (via analog input, requires P0704 to be set to 99)		
r2110[4]	Warning number	Min: -	Level:
	Datatype: U16 Unit: - Def: - P-Group: ALARMS Active: Immediately QuickComm. No Max: -		2
Displays warning information.			
A maximum of 2 active warnings (indices 0 and 1) and 2 historical warnings (indices 2 and 3) may be viewed.			
Index:			
	r2110[0] : Recent Warnings --, warning 1		
	r2110[1] : Recent Warnings --, warning 2		
	r2110[2] : Recent Warnings -1, warning 3		
	r2110[3] : Recent Warnings -1, warning 4		
Note:			
The keypad will flash while a warning is active. The LEDs indicate the warning status in this case.			
If an AOP is in use, the display will show number and text of the active warning.			
Notice:			
Indices 0 and 1 are not stored.			
P2111	Total number of warnings	Min: 0	Level:
	CStat: CT Datatype: U16 Unit: - Def: 0 P-Group: ALARMS Active: Immediately QuickComm. No Max: 4		3
Displays number of warning (up to 4) since last reset. Set to 0 to reset the warning history.			

r2114[2]	Run time counter	Datatype: U16	Unit: -	Min: - Def: - Max: -	Level: 3
P-Group: ALARMS					

Displays run time counter
Details:
 See P0948 (fault time)

P2115[3]	AOP real time clock	Datatype: U16	Unit: -	Min: 0 Def: 0 Max: 65535	Level: 3
CStat: CT	Active: first confirm	QuickComm. No			
P-Group: ALARMS					

Displays AOP real time.
Details:
 See P0948 (fault time)

P2120	Indication counter	Datatype: U16	Unit: -	Min: 0 Def: 0 Max: 65535	Level: 4
CStat: CUT	Active: first confirm	QuickComm. No			
P-Group: ALARMS					

Indicates total number of alarm events. This parameter is incremented whenever an alarm event occurs.

P2150	Hysteresis frequency f_hys	Datatype: Float	Unit: Hz	Min: 0.00 Def: 3.00 Max: 10.00	Level: 3
CStat: CUT	Active: first confirm	QuickComm. No			
P-Group: ALARMS					

Defines hysteresis level applied for comparing frequency and speed to threshold as illustrated in the diagrams below

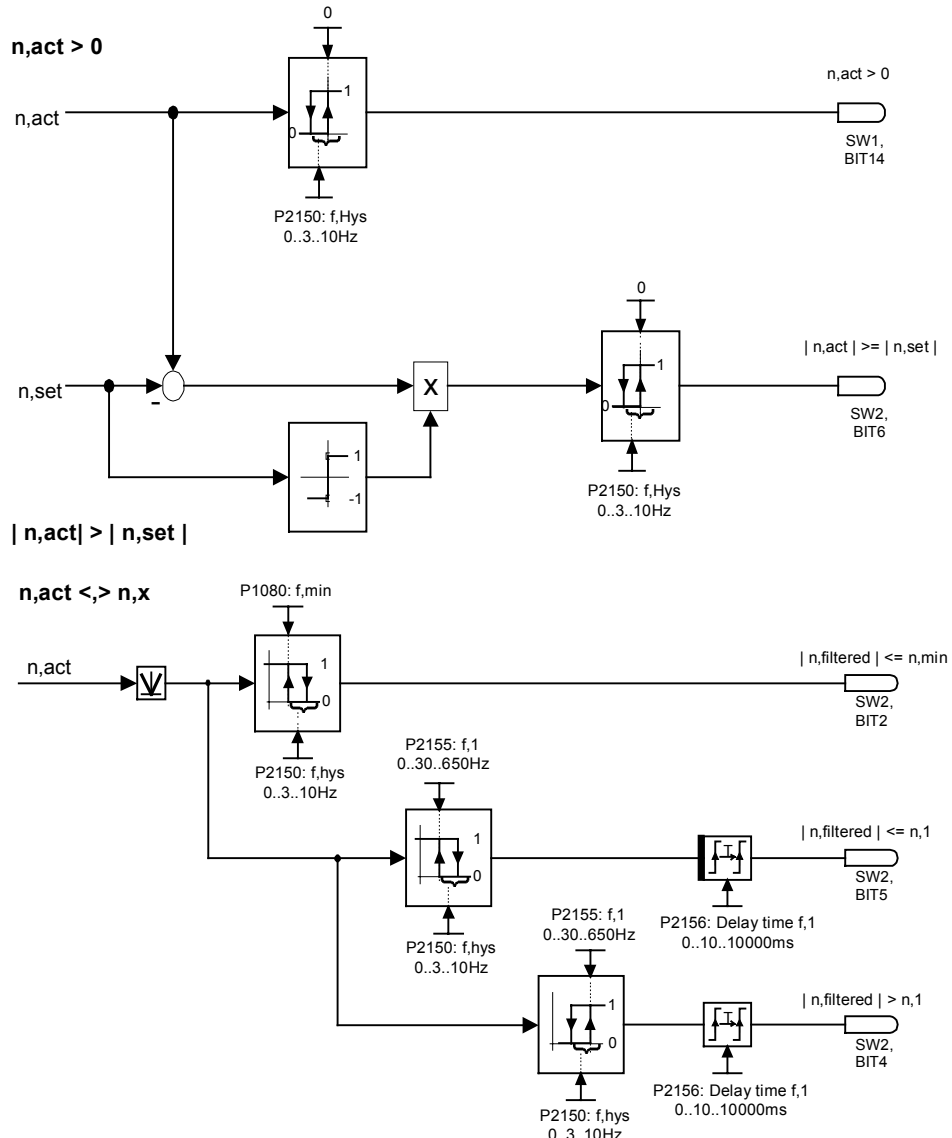

P2155	Threshold frequency f_1	Min: 0.00	Level:
	CStat: CUT	Datatype: Float	Unit: Hz
	P-Group: ALARMS	Active: first confirm	QuickComm. No Max: 650.00

Sets a threshold for comparing actual speed or frequency to threshold values f_1. This threshold controls status bits 4 and 5 in status word 2 (r0053).

Details:

See diagram in P2150 (hysteresis frequency f_hys)

P2156	Delay time of threshold freq f_1	Min: 0	Level:
	CStat: CUT	Datatype: U16	Unit: ms
	P-Group: ALARMS	Active: first confirm	QuickComm. No Max: 10000

Sets delay time prior to threshold frequency f_1 comparison (P2155).

Details:

See diagram in P2150 (hysteresis frequency f_hys)

P2164	Hysteresis frequency deviation	Min: 0.00	Level:
	CStat: CUT	Datatype: Float	Unit: Hz
	P-Group: ALARMS	Active: first confirm	QuickComm. No Max: 10.00

Hysteresis frequency for detecting permitted deviation (from setpoint) or frequency or speed. This frequency controls bit 8 in status word 1 (P0052) and bit 6 in status word 2 (P0053)

$$n_{act} = n_{set}$$

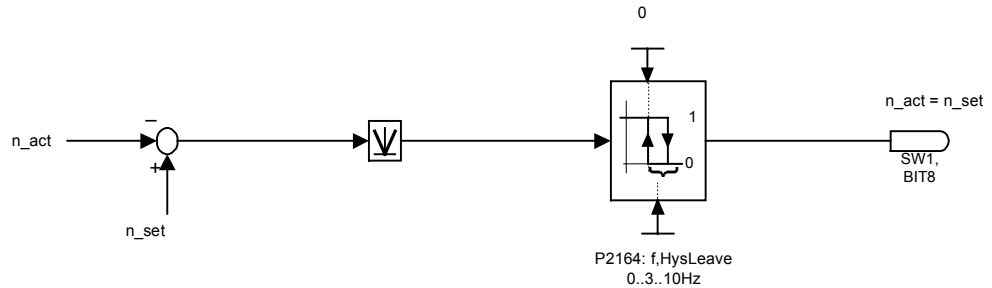

P2167	Switch-off frequency f_off	Min: 0.00	Level:
	CStat: CUT	Datatype: Float	Unit: Hz
	P-Group: ALARMS	Active: first confirm	QuickComm. No Max: 10.00

Sets frequency threshold below which inverter switches off.

If the frequency falls below this threshold, bit 1 in status word 2 (r0053) is set.

$$|n_{act}| < n_{off}$$

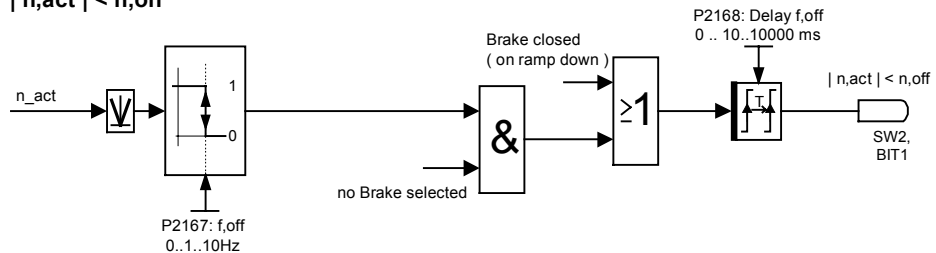

Dependency:

Switched off only if OFF1 or OFF3 active.

P2168	Delay time T_off	Min: 0	Level:
	CStat: CUT	Datatype: U16	Unit: ms
	P-Group: ALARMS	Active: first confirm	QuickComm. No Max: 10000

Defines time for which the inverter may operate below switch-off frequency (P2167) before switch off occurs.

Dependency:

Active if holding brake (P1215) not parameterized.

Details:

See diagram in P2167 (switch-off frequency)

P2170	Threshold current I_{thresh}	Min: 0.0	Level:
	CStat: CUT	Datatype: Float	Unit: %
	P-Group: ALARMS	Active: first confirm	QuickComm. No Max: 400.0

Level:
3

Defines threshold current in [%] relative to P0305 (rated motor current) to be used in comparisons of I_{act} and I_{Thresh} as illustrated in the diagram below.

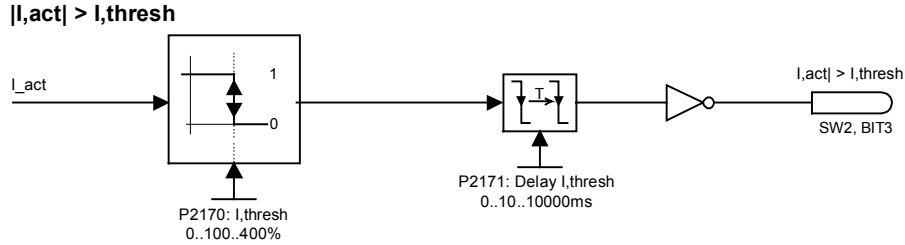

Note: This threshold controls bit 3 in status word 3 (P0053).

P2171	Delay time current	Min: 0	Level:
	CStat: CUT	Datatype: U16	Unit: ms
	P-Group: ALARMS	Active: first confirm	QuickComm. No Max: 10000

Level:
3

Defines delay time prior to activation of current comparison.

Details: See diagram in P2170 (threshold current I_{thresh})

P2172	Threshold DC-link voltage	Min: 0	Level:
	CStat: CUT	Datatype: U16	Unit: V
	P-Group: ALARMS	Active: first confirm	QuickComm. No Max: 2000

Level:
3

Defines DC link voltage to be compared to actual voltage as illustrated in the diagram below.

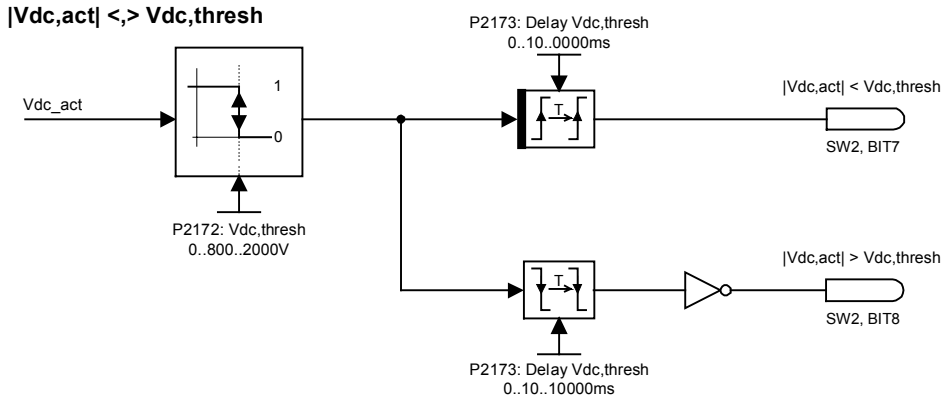

Note: This voltage controls bits 7 and 8 in status word 3 (P0053).

P2173	Delay time DC-link voltage	Min: 0	Level:
	CStat: CUT	Datatype: U16	Unit: ms
	P-Group: ALARMS	Active: first confirm	QuickComm. No Max: 10000

Level:
3

Defines delay time prior to activation of threshold comparison.

Details: See diagram in P2172 (threshold DC-link voltage)

P2179	Current limit for no load ident.				Min: 0.0	Level: 3
	CStat: CUT	Datatype: Float	Unit: %	Def: 3.0		
	P-Group: ALARMS	Active: first confirm	QuickComm. No	Max: 10.0		

Threshold current for A0922 (load missing) in [%] relative to P0305 (rated motor current) as illustrated in the diagram below.

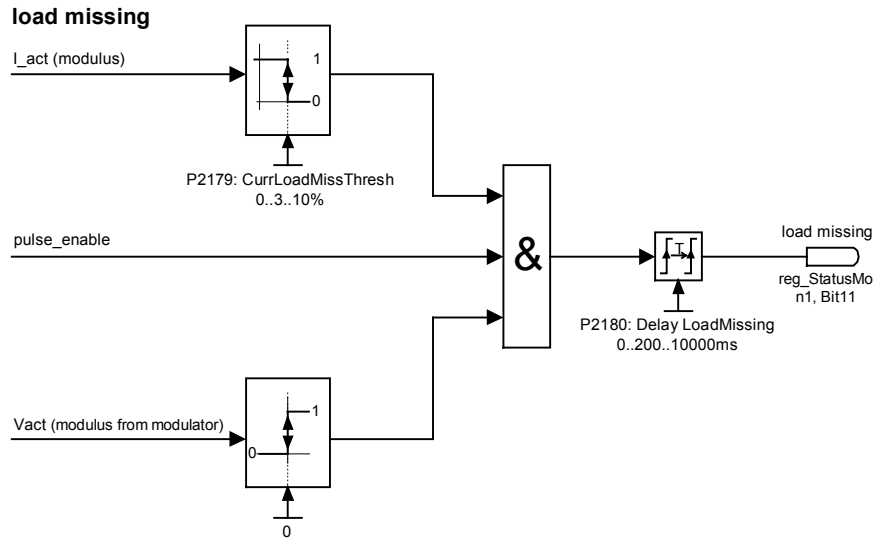
**Note:**

It may be that the motor is not connected (load missing) or a phase could be missing.

Notice:

If a motor setpoint cannot be entered and the current limit (P2179) is not exceeded, Alarm A0922 (no load applied) is issued when delay time (P2180) expires.

P2180	Delay time for no load ident.				Min: 0	Level: 3
	CStat: CUT	Datatype: U16	Unit: ms	Def: 2000		
	P-Group: ALARMS	Active: first confirm	QuickComm. No	Max: 10000		

Delay time load missing

Note:

It may be that the motor is not connected (load missing) or a phase could be missing.

Notice:

If a motor setpoint cannot be entered and the current limit (P2179) is not exceeded, Alarm A0922 (no load applied) is issued when delay time (P2180) expires.

Details:

See diagram in P2179 (current limit for no load identification)

r2197	CO/BO: Monitoring word 1			Min: -	Level: 2
	Datatype: U16	Unit: -	Def: -	Max: -	
	P-Group: ALARMS				

Monitoring word 1 which indicates the state of monitor functions. Each bit represents one monitor function.

Bitfields:

Bit00	Act. freq. r0024	<=	P1080	0	NO
				1	YES
Bit01	Act. freq. r0024	<=	P2155	0	NO
				1	YES
Bit02	Act. freq. r0024	>	P2155	0	NO
				1	YES
Bit03	Act. freq. r0024	>	zero	0	NO
				1	YES
Bit04	Act. freq. r0024	>=	setp.	0	NO
				1	YES
Bit05	Act. freq. r0024	<=	P2167	0	NO
				1	YES
Bit06	Act. freq. r0024	>=	P1082	0	NO
				1	YES
Bit07	Act. freq. r0024	=	setp.	0	NO
				1	YES
Bit08	Act. current r0027	>=	P2170	0	NO
				1	YES
Bit09	Act. unfilt. Vdc	<	P2172	0	NO
				1	YES
Bit10	Act. unfilt. Vdc	>	P2172	0	NO
				1	YES
Bit11	No load condition			0	NO
				1	YES

P2200	BI: Enable PID controller			Min: 0:0	Level: 2
	CStat: CT	Datatype: U32	Unit: -	Def: 0:0	
	P-Group: TECH	Active: Immediately	QuickComm. No	Max: 4000:0	

PID mode Allows user to enable/disable the PID controller. Setting to 1 enables the PID closed-loop controller.

Dependency:

Setting 1 automatically disables normal ramp times set in P1120 and P1121 and the normal frequency setpoints.

Following an OFF1 or OFF3 command, however, the inverter frequency will ramp down to zero using the ramp time set in P1121 (P1135 for OFF3).

Note:

The PID setpoint source is selected using P2253. The PID setpoint and the PID feedback signal are interpreted as [%] values (not [Hz]). The output of the PID controller is displayed as [%] and then normalized into [Hz] through P2000 (reference frequency) when PID is enabled.

In level 3, the PID controller source enable can also come from the digital inputs in settings 722.0 to 722.2 for DIN1 to DIN3 or from any other BiCo source

Notice:

The minimum and maximum motor frequencies (P1080 and P1082) as well as the skip frequencies (P1091 to P1094) remain active on the inverter output. However, enabling skip frequencies with PID control can produce instabilities.

P2201	Fixed PID setpoint 1	Datatype: Float	Unit: %	Min: -200.00	Level: 2
	CStat: CUT	Active: first confirm	QuickComm. No	Def: 0.00	
	P-Group: TECH			Max: 200.00	

Defines Fixed PID Setpoint 1

In addition, you can set any of the digital input parameters to Fixed PID Setpoint via the digital inputs (P0701 - P0703).

There are three selection modes for the PID fixed setpoint:

1 Direct selection (P0701 = 15 or P0702 = 15, etc)

In this mode of operation, 1 digital input selects one PID fixed setpoint.

2 Direct selection with ON command (P0701 = 16 or P0702 = 16, etc.)

Description as for 1), except that this type of selection issues an ON command concurrent with any setpoint selection.

3 Binary Coded Decimal selection (P0701 - P0703 = 17)

Using this method to select the PID Fixed Setpoint allows you to choose up to 7 different PID setpoints. The setpoints are selected according to the following table:

		DIN3	DIN2	DIN1
	OFF	Inactive	Inactive	Inactive
P2201	FF1	Inactive	Inactive	Active
P2202	FF2	Inactive	Active	Inactive
P2203	FF3	Inactive	Active	Active
P2204	FF4	Active	Inactive	Inactive
P2205	FF5	Active	Inactive	Active
P2206	FF6	Active	Active	Inactive
P2207	FF7	Active	Active	Active

Dependency:

P2000 = 1 required in user access level 2 to enable setpoint source.

In mode 1 (above):

ON command required to start motor (enable pulses).

In mode 2 (above):

If inputs programmed to PID fixed setpoint and selected together, the selected setpoints are summed.

Note:

You may mix different types of frequencies; however, remember that they will be summed if selected together.

P2201 = 100 % corresponds to 4000 hex

P2202	Fixed PID setpoint 2	Datatype: Float	Unit: %	Min: -200.00	Level: 2
	CStat: CUT	Active: first confirm	QuickComm. No	Def: 10.00	
	P-Group: TECH			Max: 200.00	

Defines Fixed PID Setpoint 2

Details:

See P2201 (Fixed PID Setpoint 1).

P2203	Fixed PID setpoint 3	Datatype: Float	Unit: %	Min: -200.00	Level: 2
	CStat: CUT	Active: first confirm	QuickComm. No	Def: 20.00	
	P-Group: TECH			Max: 200.00	

Defines Fixed PID Setpoint 3

Details:

See P2201 (Fixed PID Setpoint 1).

P2204	Fixed PID setpoint 4	Datatype: Float	Unit: %	Min: -200.00	Level: 2
	CStat: CUT	Active: first confirm	QuickComm. No	Def: 30.00	
	P-Group: TECH			Max: 200.00	

Defines Fixed PID Setpoint 4

Details:

See P2201 (Fixed PID Setpoint 1).

P2205	Fixed PID setpoint 5	CStat: CUT P-Group: TECH	Datatype: Float Active: first confirm	Unit: % QuickComm. No	Min: -200.00 Def: 40.00 Max: 200.00	Level: 2
	Defines Fixed PID Setpoint 5					
	Details: See P2201 (Fixed PID Setpoint 1).					
P2206	Fixed PID setpoint 6	CStat: CUT P-Group: TECH	Datatype: Float Active: first confirm	Unit: % QuickComm. No	Min: -200.00 Def: 50.00 Max: 200.00	Level: 2
	Defines Fixed PID Setpoint 6					
	Details: See P2201 (Fixed PID Setpoint 1).					
P2207	Fixed PID setpoint 7	CStat: CUT P-Group: TECH	Datatype: Float Active: first confirm	Unit: % QuickComm. No	Min: -200.00 Def: 60.00 Max: 200.00	Level: 2
	Defines Fixed PID Setpoint 7					
	Details: See P2201 (Fixed PID Setpoint 1).					
P2216	Fixed PID setpoint mode - Bit 0	CStat: CT P-Group: TECH	Datatype: U16 Active: Immediately	Unit: - QuickComm. No	Min: 1 Def: 1 Max: 3	Level: 3
	Fixed frequencies for PID setpoint can be selected in three different modes. Parameter P1016 defines the mode of selection Bit 0.					
	Enum: 1 Direct selection 2 Direct selection + ON command 3 Binary coded selection + ON command					
P2217	Fixed PID setpoint mode - Bit 1	CStat: CT P-Group: TECH	Datatype: U16 Active: Immediately	Unit: - QuickComm. No	Min: 1 Def: 1 Max: 3	Level: 3
	BCD or direct selection Bit 1 for PID setpoint.					
	Enum: 1 Direct selection 2 Direct selection + ON command 3 Binary coded selection + ON command					
P2218	Fixed PID setpoint mode - Bit 2	CStat: CT P-Group: TECH	Datatype: U16 Active: Immediately	Unit: - QuickComm. No	Min: 1 Def: 1 Max: 3	Level: 3
	BCD or direct selection Bit 2 for PID setpoint.					
	Enum: 1 Direct selection 2 Direct selection + ON command 3 Binary coded selection + ON command					
P2220	BI: Fixed PID setp. select Bit 0	CStat: CT P-Group: COMMANDS	Datatype: U32 Active: Immediately	Unit: - QuickComm. No	Min: 0:0 Def: 0:0 Max: 4000:0	Level: 3
	Defines command source of fixed PID setpoint selection Bit 0					
	Settings: 722.0 = Digital input 1 (requires P0701 to be set to 99, BICO) 722.1 = Digital input 2 (requires P0702 to be set to 99, BICO) 722.2 = Digital input 3 (requires P0703 to be set to 99, BICO) 722.3 = Digital input 4 (via analog input, requires P0704 to be set to 99)					
P2221	BI: Fixed PID setp. select Bit 1	CStat: CT P-Group: COMMANDS	Datatype: U32 Active: Immediately	Unit: - QuickComm. No	Min: 0:0 Def: 0:0 Max: 4000:0	Level: 3
	Defines command source of fixed PID setpoint selection Bit 1.					
	Settings: 722.0 = Digital input 1 (requires P0701 to be set to 99, BICO) 722.1 = Digital input 2 (requires P0702 to be set to 99, BICO) 722.2 = Digital input 3 (requires P0703 to be set to 99, BICO)					

P2222	BI: Fixed PID setp. select Bit 2	Min: 0:0	Level: 3
	CStat: CT Datatype: U32 Unit: -	Def: 0:0	
	P-Group: COMMANDS Active: Immediately QuickComm. No	Max: 4000:0	

Defines command source of fixed PID setpoint selection Bit 2

Settings:

722.0 = Digital input 1 (requires P0701 to be set to 99, BICO)
 722.1 = Digital input 2 (requires P0702 to be set to 99, BICO)
 722.2 = Digital input 3 (requires P0703 to be set to 99, BICO)

r2224	CO: Act. fixed PID setpoint	Min: -	Level: 2
	Datatype: Float Unit: %	Def: -	
	P-Group: TECH	Max: -	

Displays total output of PID fixed setpoint selection.

Note:

r2224 = 100 % corresponds to 4000 hex

P2231	Setpoint memory of PID-MOP	Min: 0	Level: 2
	CStat: CUT Datatype: U16 Unit: -	Def: 0	
	P-Group: TECH Active: first confirm QuickComm. No	Max: 1	

Setpoint memory

Enum:

0 PID-MOP setpoint will not be stored
 1 PID-MOP setpoint will be stored (P2240 is updated)

Dependency:

If 0 selected, setpoint returns to value set in P2240 (setpoint of PID-MOP) after an OFF command

If 1 is selected, active setpoint is 'remembered' and P2240 updated with current value.

Details:

See P2240 (setpoint of PID-MOP)

P2232	Inhibit rev. direct. of PID-MOP	Min: 0	Level: 2
	CStat: CT Datatype: U16 Unit: -	Def: 1	
	P-Group: TECH Active: Immediately QuickComm. No	Max: 1	

Inhibits reverse setpoint selection when PID motor potentiometer is chosen either as a main setpoint of additional setpoint (using P1000)

Enum:

0 Reserve direction is allowed
 1 Reserve direction inhibited

Note:

Setting 0 enables a change of motor direction using the motor potentiometer setpoint (increase/decrease frequency either by using digital inputs or motor potentiometer up/down buttons).

P2235	BI: Enable PID-MOP (UP-cmd)	Min: 0:0	Level: 3
	CStat: CT Datatype: U32 Unit: -	Def: 19:13	
	P-Group: COMMANDS Active: Immediately QuickComm. No	Max: 4000:0	

Defines source of UP command.

Settings:

722.0 = Digital input 1 (requires P0701 to be set to 99, BICO)
 722.1 = Digital input 2 (requires P0702 to be set to 99, BICO)
 722.2 = Digital input 3 (requires P0703 to be set to 99, BICO)

19.D = Keypad UP cursor

P2236	BI: Enable PID-MOP (DOWN-cmd)	Min: 0:0	Level: 3
	CStat: CT Datatype: U32 Unit: -	Def: 19:14	
	P-Group: COMMANDS Active: Immediately QuickComm. No	Max: 4000:0	

Defines source of DOWN command.

Settings:

722.0 = Digital input 1 (requires P0701 to be set to 99, BICO)
 722.1 = Digital input 2 (requires P0702 to be set to 99, BICO)
 722.2 = Digital input 3 (requires P0703 to be set to 99, BICO)
 722.3 = Digital input 4 (via analog input, requires P0704 to be set to 99)

19.E = Keypad DOWN cursor

P2240	Setpoint of PID-MOP	Datatype: Float	Unit: %	Min: -200.00	Level: 2
	CStat: CUT	Active: first confirm	QuickComm. No	Def: 10.00	
	P-Group: TECH			Max: 200.00	

Setpoint of the motor potentiometer.

Allows user to set a digital PID setpoint in [%].

Settings:

- 722.0 = Digital input 1 (requires P0701 to be set to 99, BICO)
- 722.1 = Digital input 2 (requires P0702 to be set to 99, BICO)
- 722.2 = Digital input 3 (requires P0703 to be set to 99, BICO)
- 722.3 = Digital input 4 (via analog input, requires P0704 to be set to 99)

19.D = Keypad UP cursor

Dependency:

To change setpoint:

1. Use UP / DOWN key on BOP or
2. Set P0702/P0703 = 13/14 (function of digital inputs 2 and 3)

Note:

P2240 = 100 % corresponds to 4000 hex

r2250	CO: Output setpoint of PID-MOP	Datatype: Float	Unit: %	Min: -	Level: 2
	P-Group: TECH			Def: -	
				Max: -	

Displays output setpoint of motor potentiometer in [%].

Note:

r2250 = 100 % corresponds to 4000 hex

P2253	CI: PID setpoint	Datatype: U32	Unit: -	Min: 0:0	Level: 2
	CStat: CUT	Active: Immediately	QuickComm. No	Def: 0:0	
	P-Group: TECH			Max: 4000:0	

Defines setpoint source for PID setpoint input.

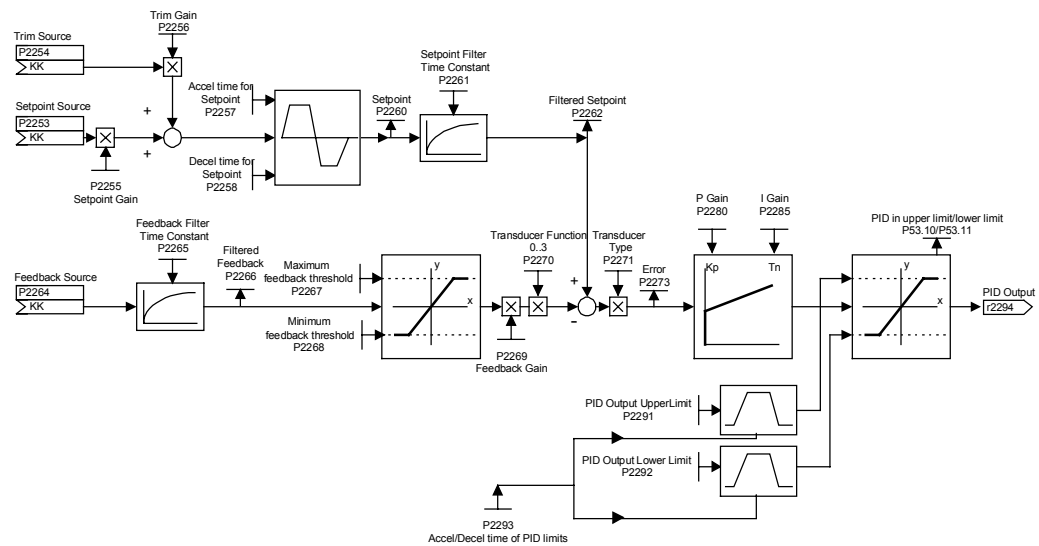

This parameter allows the user to select the source of the PID setpoint. Normally, a digital setpoint is selected either using a fixed PID setpoint or an active setpoint.

Settings:

- 755 = Analog input 1
- 2224 = Fixed PI setpoint (see P2201 to P2207)
- 2250 = Active PI setpoint (see P2240)

P2254	CI: PID trim source	Datatype: U32	Unit: -	Min: 0:0	Level: 3
	CStat: CUT	Active: Immediately	QuickComm. No	Def: 0:0	
	P-Group: TECH			Max: 4000:0	

Selects trim source for PID setpoint. This signal is multiplied by the trim gain and added to the PID setpoint.

Settings:

- 755 = Analog input 1
- 2224 = Fixed PI setpoint (see P2201 to P2207)
- 2250 = Active PI setpoint (see P2240)

P2255	PID setpoint gain factor	Min: 0.00	Level:
	CStat: CUT	Datatype: Float	Def: 100.00
	P-Group: TECH	Active: first confirm	QuickComm. No Max: 100.00
Gain factor for PID setpoint. The trim input is multiplied by this gain factor to produce a suitable ratio between setpoint and trim.			
P2256	PID trim gain factor	Min: 0.00	Level:
	CStat: CUT	Datatype: Float	Def: 100.00
	P-Group: TECH	Active: first confirm	QuickComm. No Max: 100.00
Gain factor for PID trim. This gain factor scales the trim signal, which is added to the main PID setpoint.			
P2257	Ramp-up time for PID setpoint	Min: 0.00	Level:
	CStat: CUT	Datatype: Float	Unit: s
	P-Group: TECH	Active: first confirm	QuickComm. No Max: 650.00

Sets the ramp-up time for the PID setpoint.

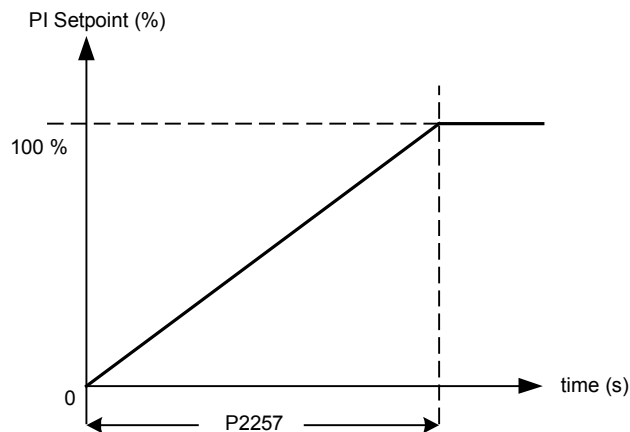

Dependency:

P2200 = 1 (PID control is enabled) disable normal ramp-up time (P1120).

PID ramp time effective only on PID setpoint and only active when PID setpoint is changed or when RUN command is given (when PID uses this ramp to reach its value from 0 %).

Notice:

Setting the ramp-up time too short may cause the inverter to trip, on overcurrent for example.

P2258	Ramp-down time for PID setpoint	Min: 0.00	Level: 2	
	CStat: CUT	Datatype: Float		Unit: s
	P-Group: TECH	Active: first confirm		QuickComm. No
		Def: 1.00		
		Max: 650.00		

Sets ramp-down time for PID setpoint.

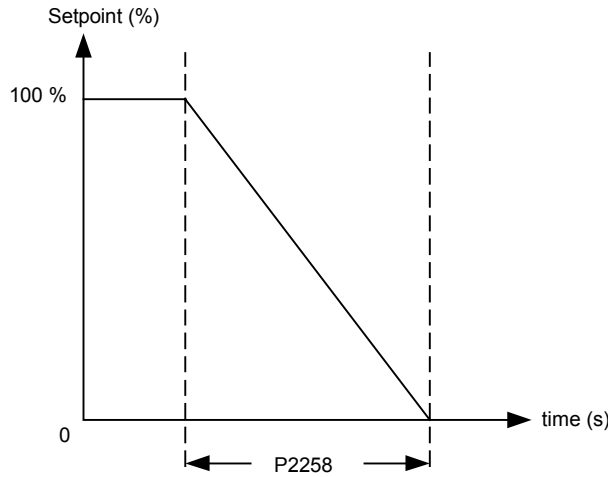

Dependency:

P2200 = 1 (PID control is enabled) disables normal ramp-up time (P1120).

PID setpoint ramp effective only on PID setpoint changes.

P1121 (ramp-down time) and P1135 (OFF3 ramp-down time) define the ramp times used after OFF1 and OFF2 respectively.

Notice:

Setting the ramp-down time too short can cause the inverter to trip on overvoltage (F0002) / overcurrent (F0001).

r2260	CO: Act. PID setpoint	Min: -	Level: 2	
		Datatype: Float		Unit: %
	P-Group: TECH	Active: first confirm		QuickComm. No
		Def: -		
		Max: -		

Displays total active PID setpoint in [%].

Note:

r2260 = 100 % corresponds to 4000 hex

P2261	PID setpoint filter timeconstant	Min: 0.00	Level: 3	
	CStat: CUT	Datatype: Float		Unit: s
	P-Group: TECH	Active: first confirm		QuickComm. No
		Def: 0.00		
		Max: 60.00		

Sets a time constant for smoothing the PID setpoint.

Note:

0 = no smoothing

r2262	CO: Act. PID filtered setpoint	Min: -	Level: 3	
		Datatype: Float		Unit: %
	P-Group: TECH	Active: first confirm		QuickComm. No
		Def: -		
		Max: -		

Displays PID setpoint in [%] after smoothing.

Note:

r2262 = 100 % corresponds to 4000 hex

P2264	CI: PID feedback	Min: 0:0	Level: 2	
	CStat: CUT	Datatype: U32		Unit: -
	P-Group: TECH	Active: Immediately		QuickComm. No
		Def: 755:0		
		Max: 4000:0		

Selects the source of the PID feedback signal.

Settings:

755 = Analog input 1 setpoint

2224 = Fixed PID setpoint

2250 = Output setpoint of PID-MOP

Note:

When analog input is selected, offset and gain can be implemented using parameters P0756 to P0760.

P2265	PID feedback filter timeconstant	Min: 0.00	Level: 2	
	CStat: CUT	Datatype: Float		Unit: s
	P-Group: TECH	Active: first confirm		QuickComm. No
		Def: 0.00		
		Max: 60.00		

Defines time constant for PID feedback filter.

r2266	CO: PID filtered feedback	Datatype: Float	Unit: %	Min: - Def: - Max: -	Level: 2
	P-Group: TECH				
	Displays PID feedback signal in [%].				
Note:	r2266 = 100 % corresponds to 4000 hex				
P2267	Max. value for PID feedback	Datatype: Float	Unit: %	Min: -200.00 Def: 100.00 Max: 200.00	Level: 3
	CStat: CUT		Active: first confirm	QuickComm. No	
	P-Group: TECH				
	Sets the upper limit for the value of the feedback signal in [%].				
Note:	P2267 = 100 % corresponds to 4000 hex				
Notice:	When PID is enabled (P2200 = 1) and the signal rises above this value, the inverter will trip with F0222 .				
P2268	Min. value for PID feedback	Datatype: Float	Unit: %	Min: -200.00 Def: 0.00 Max: 200.00	Level: 3
	CStat: CUT		Active: first confirm	QuickComm. No	
	P-Group: TECH				
	Sets lower limit for value of feedback signal in [%].				
Note:	P2268 = 100 % corresponds to 4000 hex				
Notice:	When PID is enabled (P2200 = 1) and the signal rises above this value, the inverter will trip with F0221.				
P2269	Gain applied to PID feedback	Datatype: Float	Unit: -	Min: 0.00 Def: 100.00 Max: 500.00	Level: 3
	CStat: CUT		Active: first confirm	QuickComm. No	
	P-Group: TECH				
	Allows the user to scale the PID feedback as a percentage value [%].				
	A gain of 100.0 % means that feedback signal has not changed from its default value.				
P2270	PID feedback function selector	Datatype: U16	Unit: -	Min: 0 Def: 0 Max: 3	Level: 3
	CStat: CUT		Active: first confirm	QuickComm. No	
	P-Group: TECH				
	Applies mathematical functions to the PID feedback signal, allowing multiplication of the result by P2269 (gain applied to PID feedback).				
Enum:	0 Disabled				
	1 Square root (root(x))				
	2 Square (x*x)				
	3 Cube (x*x*x)				
P2271	PID tranducer type	Datatype: U16	Unit: -	Min: 0 Def: 0 Max: 1	Level: 2
	CStat: CUT		Active: first confirm	QuickComm. No	
	P-Group: TECH				
	Allows the user to select the transducer type for the PID feedback signal.				
Value:	0 : [default] If the feedback signal is less than the PID setpoint, the PID controller will increase motor speed to correct this.				
	1 : If the feedback signal is greater than the PID setpoint, the PID controller will reduce motor speed to correct this.				
Enum:	0 Disabled				
	1 Inversion of PID feedback signal				
Notice:	It is essential that you select the correct tranducer type.				
	If you are unsure whether 0 or 1 is applicable, you can determine the correct type as follows:				
	1 Disable the PID function (P2200 = 0).				
	2 Increase the motor frequency while measuring the feedback signal.				
	3 If the feedback signal increases with an increase in motor frequency, the PID transducer type should be 0.				
	4 If the feedback signal decreases with an increase in motor frequency the PID transducer type should be set to 1.				
r2272	CO: PID scaled feedback	Datatype: Float	Unit: %	Min: - Def: - Max: -	Level: 2
	P-Group: TECH				
	Displays PID scaled feedback signal in [%].				
Note:	r2272 = 100 % corresponds to 4000 hex				

r2273	CO: PID error	Datatype: Float	Unit: %	Min: -	Def: -	Max: -	Level:
	P-Group: TECH						2

Displays PID error (difference) signal between setpoint and feedback signals in [%].

Note:

r2273 = 100 % corresponds to 4000 hex

P2280	PID proportional gain	Datatype: Float	Unit: -	Min: 0.000	Def: 3.000	Max: 65.000	Level:
	CStat: CUT	Active: first confirm	QuickComm. No				2

Allows user to set proportional gain for PID controller.

The PID controller is implemented using the standard model.

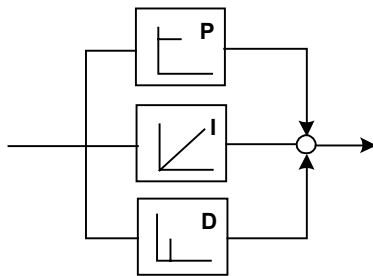

For best results, enable both P and I terms.

Dependency:

If P term = 0, I term acts on the square of the error signal.

Note:

If the system is prone to sudden step changes in the feedback signal, P term should normally be set to a small value (0.5) with a faster I term for optimum performance.

The D term (P2274) multiplies the difference between the present and previous feedback signal thus accelerating the controller reaction to an error that appears suddenly.

Notice:

The D term should be used carefully, since it can cause the controller output to fluctuate as every change in the feedback signal is amplified by the controller derivative action.

P2285	PID integral time	Datatype: Float	Unit: s	Min: 0.000	Def: 0.000	Max: 60.000	Level:
	CStat: CUT	Active: first confirm	QuickComm. No				2

Sets integral time constant for PID controller.

Details:

See P2280 (PID proportional gain).

P2291	PID output upper limit	Datatype: Float	Unit: %	Min: -200.00	Def: 100.00	Max: 200.00	Level:
	CStat: CUT	Active: first confirm	QuickComm. No				2

Sets upper limit for PID controller output in [%].

Dependency:

If F max (P1082) is greater than P2000 (reference frequency), either P2000 or P2291 (PID output upper limit) must be changed to achieve F max.

Note:

P2291 = 100 % corresponds to 4000 hex (as defined by P2000 (reference frequency)).

P2292	PID output lower limit	Datatype: Float	Unit: %	Min: -200.00	Def: 0.00	Max: 200.00	Level:
	CStat: CUT	Active: first confirm	QuickComm. No				2

Sets lower limit for the PID controller output in [%].

Dependency:

A negative value allows bipolar operation of PID controller.

Note:

P2292 = 100 % corresponds to 4000 hex

P2293	Ramp-up /-down time of PID limit				Level: 3
	CStat: CUT	Datatype: Float	Unit: s	Min: 0.00 Def: 1.00	
	P-Group: TECH	Active: first confirm	QuickComm. No	Max: 100.00	

Sets maximum ramp rate on output of PID.

When PI is enabled, the output limits are ramped up from 0 to the limits set in P2291 (PID output upper limit) and P2292 (PID output lower limit). Limits prevent large step changes appearing on the output of the PID when the inverter is started. Once the limits have been reached, the PID controller output is instantaneous.

These ramp times are used whenever a RUN command is issued.

Note:

If an OFF1 or OFF 3 are issued, the inverter output frequency ramps down as set in P1121 (ramp-down time) or P1135 (OFF3 ramp-down time).

r2294	CO: Act. PID output				Level: 2
	Datatype: Float	Unit: %	Min: -	Def: -	
	P-Group: TECH	Max: -			

Displays PID output in [%]

Note:

r2294 = 100 % corresponds to 4000 hex

P3900	End of quick commissioning				Level: 1
	CStat: C	Datatype: U16	Unit: -	Min: 0 Def: 0	
	P-Group: QUICK	Active: Immediately	QuickComm. Yes	Max: 3	

Performs calculations necessary for optimized motor operation.

After completion of calculation, P3900 and P0010 (parameter groups for commissioning) are automatically reset to their original value 0.

Enum:

- 0 No quick commissioning
- 1 Start quick commissioning with factory reset
- 2 Start quick commissioning
- 3 Start quick commissioning only for motor data

Dependency:

Changeable only when P0010 = 1 (quick commissioning)

Note:

When setting 1 is selected, only the parameter settings carried out via the commissioning menu "Quick commissioning", are retained; all other parameter changes, including the I/O settings, are lost. Motor calculations are also performed.

When setting 2 is selected, only those parameters, which depend on the parameters in the commissioning menu "Quick commissioning" (P0010 = 1) are calculated. The I/O settings are also reset to default and the motor calculations performed.

When setting 3 is selected, only the motor and controller calculations are performed. Exiting quick commissioning with this setting saves time (for example, if only motor rating plate data have been changed).

Calculates a variety of motor parameters, overwriting previous values. These include P0344 (Level 3, motor weight), P0350 (Level 3, demagnetization time), P2000 (reference frequency), P2002 (Level 3, reference current).

P3950	Access of hidden parameter				Level: 4
	CStat: CUT	Datatype: U16	Unit: -	Min: 0 Def: 0	
	P-Group: ALWAYS	Active: Immediately	QuickComm. No	Max: 255	

Accesses special parameters for development (expert only) and factory functionality (calibration parameter).

r3954[13]	CM version and GUI ID	Datatype: U16	Unit: -	Min: - Def: - Max: -	Level: 4
------------------	------------------------------	----------------------	----------------	---	---------------------------

P-Group: -

Used to classify firmware (only for SIEMENS internal purposes).

Index:

- r3954[0] : CM version (major release)
- r3954[1] : CM version (minor release)
- r3954[2] : CM version (baselevel or patch)
- r3954[3] : GUI ID
- r3954[4] : GUI ID
- r3954[5] : GUI ID
- r3954[6] : GUI ID
- r3954[7] : GUI ID
- r3954[8] : GUI ID
- r3954[9] : GUI ID
- r3954[10] : GUI ID
- r3954[11] : GUI ID major release
- r3954[12] : GUI ID minor release

r3955	Version for DriveMonitor	Datatype: U16	Unit: -	Min: - Def: - Max: -	Level: H
--------------	---------------------------------	----------------------	----------------	---	---------------------------

P-Group: -

Displays the version for DriveMonitor.

P3980	Commissioning command selection	Datatype: U16	Unit: -	Min: 0 Def: 0 Max: 66	Level: 4
--------------	--	----------------------	----------------	--	---------------------------

P-Group: -

Toggles command and setpoint sources between freely programmable BICO parameters and fixed command/setpoint profiles for commissioning.

The command and setpoint sources can be changed independently. The tens digit selects the command source, the ones digit the setpoint source.

Enum:

- | | | |
|----|-----------------------|----------------------------|
| 0 | Cmd = BICO parameter | Setpoint = BICO parameter |
| 1 | Cmd = BICO parameter | Setpoint = MOP setpoint |
| 2 | Cmd = BICO parameter | Setpoint = Analog setpoint |
| 3 | Cmd = BICO parameter | Setpoint = Fixed frequency |
| 4 | Cmd = BICO parameter | Setpoint = USS on BOP link |
| 5 | Cmd = BICO parameter | Setpoint = USS on COM link |
| 6 | Cmd = BICO parameter | Setpoint = CB on COM link |
| 10 | Cmd = BOP | Setpoint = BICO parameter |
| 11 | Cmd = BOP | Setpoint = MOP setpoint |
| 12 | Cmd = BOP | Setpoint = Analog setpoint |
| 13 | Cmd = BOP | Setpoint = Fixed frequency |
| 14 | Cmd = BOP | Setpoint = USS on BOP link |
| 15 | Cmd = BOP | Setpoint = USS on COM link |
| 16 | Cmd = BOP | Setpoint = CB on COM link |
| 40 | Cmd = USS on BOP link | Setpoint = BICO parameter |
| 41 | Cmd = USS on BOP link | Setpoint = MOP setpoint |
| 42 | Cmd = USS on BOP link | Setpoint = Analog setpoint |
| 43 | Cmd = USS on BOP link | Setpoint = Fixed frequency |
| 44 | Cmd = USS on BOP link | Setpoint = USS on BOP link |
| 45 | Cmd = USS on BOP link | Setpoint = USS on COM link |
| 46 | Cmd = USS on BOP link | Setpoint = CB on COM link |
| 50 | Cmd = USS on COM link | Setpoint = BICO parameter |
| 51 | Cmd = USS on COM link | Setpoint = MOP setpoint |
| 52 | Cmd = USS on COM link | Setpoint = Analog setpoint |
| 53 | Cmd = USS on COM link | Setpoint = Fixed frequency |
| 54 | Cmd = USS on COM link | Setpoint = USS on BOP link |
| 55 | Cmd = USS on COM link | Setpoint = USS on COM link |
| 56 | Cmd = USS on COM link | Setpoint = CB on COM link |
| 60 | Cmd = CB on COM link | Setpoint = BICO parameter |
| 61 | Cmd = CB on COM link | Setpoint = MOP setpoint |
| 62 | Cmd = CB on COM link | Setpoint = Analog setpoint |
| 63 | Cmd = CB on COM link | Setpoint = Fixed frequency |
| 64 | Cmd = CB on COM link | Setpoint = USS on BOP link |
| 65 | Cmd = CB on COM link | Setpoint = USS on COM link |
| 66 | Cmd = CB on COM link | Setpoint = CB on COM link |

P3981	Reset active fault	Datatype: U16	Unit: -	Min: 0	Level: 4
	CStat: CT	Active: Immediately	QuickComm. No	Def: 0	
	P-Group: ALARMS			Max: 1	
	Resets active faults when changed from 0 to 1.				
Enum:	0 No fault reset				
	1 Reset fault				
Note:	Automatically reset to 0.				
Details:	See P0947 (last fault code)				
r3986[2]	Number of parameters	Datatype: U16	Unit: -	Min: -	Level: 4
	P-Group: -			Def: -	
				Max: -	
	Number of parameters on the drive				
Index:	r3986[0] : Read only				
	r3986[1] : Read & write				

2 Alarms and Warnings

2.1 MICROMASTER 420 fault messages

In the event of a failure, the inverter switches off and a fault code appears on the display.

NOTE

To reset the fault code, one of three methods listed below can be used:

1. Cycle the power to the drive.
2. Press the  button on the BOP or AOP.
3. Via Digital Input 3 (default setting)

Fault	Possible Causes	Diagnose & Remedy	Reaction
F0001 Overcurrent	<ul style="list-style-type: none"> ➤ Motor power does not correspond to the inverter power ➤ Motor lead short circuit ➤ Earth fault 	Check the following: <ol style="list-style-type: none"> 1. Motor power (P0307) must correspond to inverter power (P0206) 2. Cable length limits must not be exceeded 3. Motor cable and motor must have no short-circuits or earth faults 4. Motor parameters must match the motor in use 5. Value of stator resistance (P0350) must be correct 6. Motor must not be obstructed or overloaded <ul style="list-style-type: none"> ➤ Increase the ramp time ➤ Reduce the boost level 	OFF2
F0002 Overvoltage	<ul style="list-style-type: none"> ➤ DC-link voltage (r0026) exceeds trip level (P2172) ➤ Overvoltage can be caused either by too high main supply voltage or if motor is in regenerative mode ➤ Regenerative mode can be caused by fast ramp downs or if the motor is driven from an active load 	Check the following: <ol style="list-style-type: none"> 1. Supply voltage (P0210) must lie within limits indicated on rating plate 2. DC-link voltage controller must be enabled (P1240) and parameterized properly 3. Ramp-down time (P1121) must match inertia of load 	OFF2
F0003 Undervoltage	<ul style="list-style-type: none"> ➤ Main supply failed ➤ Shock load outside specified limits 	Check the following: <ol style="list-style-type: none"> 1. Supply voltage (P0210) must lie within limits indicated on rating plate 2. Supply must not be susceptible to temporary failures or voltage reductions 	OFF2
F0004 Inverter Over-temperature	<ul style="list-style-type: none"> ➤ Ambient temperature outside of limits, ➤ Fan failure 	Check the following: <ol style="list-style-type: none"> 1. Fan must turn when inverter is running 2. Pulse frequency must be set to default value 3. Air inlet and outlet points are not obstructed Ambient temperature could be higher than specified for the inverter	OFF2
F0005 Inverter I²t	<ul style="list-style-type: none"> ➤ Inverter overloaded ➤ Duty cycle too demanding ➤ Motor power (P0307) exceeds inverter power capability (P0206) 	Check the following: <ol style="list-style-type: none"> 1. Load duty cycle must lie within specified limits 2. Motor power (P0307) must match inverter power (P0206) 	OFF2
F0011 Motor Over-temperature I²t	<ul style="list-style-type: none"> ➤ Motor overloaded ➤ Motor data incorrect ➤ Long time period operating at low speeds 	<ol style="list-style-type: none"> 1. Check motor data 2. Check loading on motor 3. Boost settings too high (P1310, P1311, P1312) 4. Check parameter for motor thermal time constant 5. Check parameter for motor I²t warning level 	OFF1
F0041 Stator resistance measurement failure	Stator resistance measurement failure	<ol style="list-style-type: none"> 1. Check if the motor is connected to the inverter 2. Check that the motor data has been entered correctly 	OFF2

Fault	Possible Causes	Diagnose & Remedy	Reaction
F0051 Parameter EEPROM Fault	Reading or writing of the non-volatile parameter storage has failed	1. Factory reset and new parameterization 2. Change inverter	OFF2
F0052 Powerstack Fault	Reading of the powerstack information has failed or the data is invalid	Change inverter	OFF2
F0060 Asic Timeout	Internal communications failure	1. Acknowledge fault 2. Change inverter if repeated	OFF2
F0070 Communications board setpoint error	No setpoint received from communications board during telegram off time	1. Check connections to the communications board 2. Check the master	OFF2
F0071 No Data for USS (RS232 link) during Telegram Off Time	No response during telegram off time via USS (BOP link)	1. Check connections to the communications board 2. Check the master	OFF2
F0072 No Data from USS (RS485 link) during Telegram Off Time	No response during telegram off time via USS (COM link)	1. Check connections to the communications board 2. Check the master	OFF2
F0080 Analogue input - lost input signal	<ul style="list-style-type: none"> ➤ Broken wire ➤ Signal out of limits 	Check connection to analogue input	OFF2
F0085 External Fault	External fault is triggered via terminal inputs	Disable terminal input for fault trigger	OFF2
F0101 Stack Overflow	Software error or processor failure	1. Run self test routines 2. Change inverter	OFF2
F0221 PI Feedback below minimum value	PID Feedback below minimum value P2268	1. Change value of P2268 2. Adjust feedback gain	OFF2
F0222 PI Feedback above maximum value	PID Feedback above maximum value P2267	1. Change value of P2267 2. Adjust feedback gain	OFF2
F0450 (Service mode only) BIST Tests Failure	Fault value 1 Some of the power section tests have failed 2 Some of the control board tests have failed 4 Some of the functional tests have failed 8 Some of the IO module tests have failed 16 The Internal RAM has failed its check on power-up	1. Inverter may run but certain actions will not function correctly 2. Replace inverter	OFF2

2.2 MICROMASTER 420 alarm messages

Fault	Possible Causes	Diagnose & Remedy	Reaction
A0501 Current Limit	<ul style="list-style-type: none"> ➤ Motor power does not correspond to the inverter power ➤ Motor leads are too short ➤ Earth faults 	<ol style="list-style-type: none"> 1. Check whether the motor power corresponds to the inverter power 2. Check that the cable length limits have not been exceeded 3. Check motor cable and motor for short-circuits and earth faults 4. Check whether the motor parameters correspond with the motor being used 5. Check the stator resistance 6. Increase the ramp-up-time 7. Reduce the boost 8. Check whether the motor is obstructed or overloaded 	--
A0502 Overvoltage limit	<ul style="list-style-type: none"> ➤ Mains supply too high ➤ Load regenerative ➤ Ramp-down time too short 	<ol style="list-style-type: none"> 1. Check that mains supply voltage is within allowable range 2. Increase ramp down times <p>Note: Vdc-max controller is active, ramp-down times will be automatically increased</p>	--
A0503 Undervoltage Limit	<ul style="list-style-type: none"> ➤ Mains supply too low ➤ Short mains interruption 	Check main supply voltage (P0210)	--
A0504 Inverter Over-temperature	Warning level of inverter heat-sink temperature (P0614) is exceeded, resulting in pulse frequency reduction and/or output frequency reduction (depending on parametrization in (P0610))	<ol style="list-style-type: none"> 1. Check if ambient temperature is within specified limits 2. Check load conditions and duty cycle 3. Check if fan is turning when drive is running 	--
A0505 Inverter i²t	Warning level is exceeded; current will be reduced if parameterized (P0610 = 1)	Check if duty cycle is within specified limits	--
A0506 Inverter Duty Cycle	Heatsink temperature and thermal junction model are outside of allowable range	Check if duty cycle are within specified limits	--
A0511 Motor Over-temperature i²t	Motor overloaded	Check the following: <ol style="list-style-type: none"> 1. P0611 (motor i²t time constant) should be set to appropriate value 2. P0614 (Motor i²t overload warning level) should be set to suitable level 3. Are long periods of operation at low speed occurring 4. Check that boost settings are not too high 	--
A0541 Motor Data Identification Active	Motor data identification (P1910) selected or running	Wait until motor identification is finished	--
A0600 RTOS Overrun Warning	Software error		
A0700 CB warning 1	CB (communication board) specific	See CB user manual	--
A0701 CB warning 2	CB (communication board) specific	See CB user manual	--
A0702 CB warning 3	CB (communication board) specific	See CB user manual	--
A0703 CB warning 4	CB (communication board) specific	See CB user manual	--
A0704 CB warning 5	CB (communication board) specific	See CB user manual	--
A0705 CB warning 6	CB (communication board) specific	See CB user manual	--
A0706 CB warning 7	CB (communication board) specific	See CB user manual	--
A0707 CB warning 8	CB (communication board) specific	See CB user manual	--
A0708 CB warning 9	CB (communication board) specific	See CB user manual	--
A0709 CB warning 10	CB (communication board) specific	See CB user manual	--

Fault	Possible Causes	Diagnose & Remedy	Reaction
A0710 CB communication error	Communication with CB (communication board) is lost	Check CB hardware	--
A0711 CB configuration error	CB (communication board) reports a configuration error	Check CB parameters	--
A0910 Vdc-max controller deactivated	Vdc max controller has been deactivated, since controller is not capable of keeping DC-link voltage (r0026) within limits (P2172) <ul style="list-style-type: none"> ➤ Occurs if main supply voltage (P0210) is permanently too high ➤ Occurs if motor is driven by an active load, causing motor to go into regenerative mode ➤ Occurs at very high load inertias, when ramping down 	Check the following: <ol style="list-style-type: none"> 1. Input voltage (P0756) lies within range? 2. Load must match In certain cases apply braking resistor	--
A0911 Vdc-max controller active	Vdc max controller is active; so ramp-down times will be increased automatically to keep DC-link voltage (r0026) within limits (P2172)	<ol style="list-style-type: none"> 1. Check parameter inverter input voltage 2. Check ramp-down times 	--
A0912 Vdc-min controller active	Vdc min controller will be activated if DC-link voltage (r0026) falls below minimum level (P2172) <ul style="list-style-type: none"> ➤ The kinetic energy of the motor is used to buffer the DC-link voltage, thus causing deceleration of the drive! ➤ So short mains failures do not necessarily lead to an undervoltage trip 		--
A0920 ADC parameters not set properly	ADC parameters should not be set to identical values, since this would produce illogical results. <ul style="list-style-type: none"> ➤ Index 0: Parameter settings for output identical ➤ Index 1: Parameter settings for input identical ➤ Index 2: Parameter settings for input do not correspond to ADC type 	Analogue input parameters should not be set to the same value as each other	--
A0921 DAC parameters not set properly	DAC parameters should not be set to identical values, since this would produce illogical results. <ul style="list-style-type: none"> ➤ Index 0: Parameter settings for output identical ➤ Index 1: Parameter settings for input identical ➤ Index 2: Parameter settings for output do not correspond to DAC type 	Analogue Output parameters should not be set to the same value as each other	--
A0922 No load applied to inverter	<ul style="list-style-type: none"> ➤ No Load is applied to the inverter ➤ As a result, some functions may not work as under normal load conditions Low output voltage eg when 0 boost applied at 0 Hz	<ol style="list-style-type: none"> 1. Check that load is applied to the inverter 2. Check motor parameters correspond to motor attached 3. As a result, some functions may not work correctly, because there is no normal load condition 	--
A0923 Both JOG Left and JOG Right are requested	Both JOG right and JOG left (P1055/P1056) have been requested. This freezes the RFG output frequency at its current value. JOG right and JOG left signals active together	Make sure that JOG right and JOG left signals are not applied simultaneously	--

Suggestions and/or Corrections

To
Siemens AG
Automation & Drives
Group
SD VM 4
P.O. Box 3269

D-91050 Erlangen
Federal Republic of Germany

[Suggestions for technical documentation](#)

From Name: Company/Service Department Address: _____ Phone: _____ / _____ Fax: _____ / _____	Suggestions Corrections
	For Publication/Manual: MICROMASTER 420 Parameter List User Documentation
	Order No.: 6SE6400-5BA00-0BP0 Version 12/01
	Should you come across any printing errors when reading this publication, please notify us on this sheet. Suggestions for improvement are also welcome.



Siemens AG
Automation and Drives Group (A&D)
Standard Drives (SD) Division
Postfach 3269, D-91050 Erlangen
Federal Republic of Germany

© Siemens AG, 2001
Subject to change without prior notice

Siemens Aktiengesellschaft

6SE6400-5BA00-0BP0

